

User Manual

Translation of the original manual.
Original language of the manual: Polish.

Modular PLC Series Ambity Line™

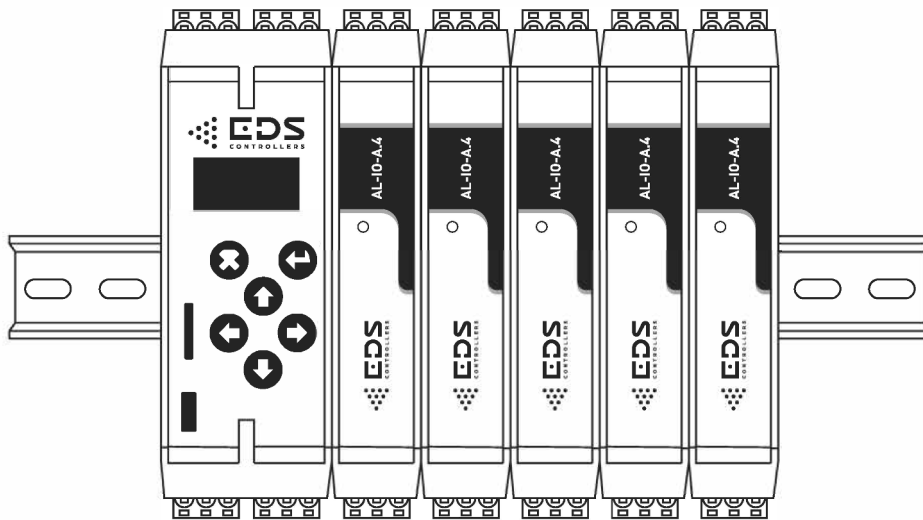

Table of Contents

1. Manufacturer details.....	3
2. Information legal.....	3
3. Change log.....	3
4. Definitions, abbreviations and symbols.....	4
5. Safety.....	5
6. System description.....	7
6.1. Modularity.....	7
6.2. Systematics and nomenclature.....	7
6.3. Configurable I/O channels.....	10
7. General characteristics of the CPU.....	11
7.1. General view and description of parts.....	11
7.2. Technical data.....	12
8. General characteristics of I/O modules.....	14
8.1. General view and description of parts.....	14
8.2. Technical data.....	14
9. First steps.....	17
9.1. Preparing for installation.....	17
9.2. Rail mounting, bus, interconnection of modules.....	17
9.3. Connecting the power supply and battery.....	20
9.4. RS-485 (Modbus RTU) Buses.....	21
9.5. Connecting to a computer.....	22
10. Method and wiring diagrams.....	24
10.1. Types and description of connectors in the CPU module.....	24
10.2. Types and description of connectors in I/O modules.....	25
10.3. Restrictions and warnings – improper use of in and out channels.....	27
10.4. Examples of connecting signals/sensors.....	27
10.4.1. Current measurement 0/4-20mA.....	27
10.4.2. Voltage measurement 0-10/24V.....	28
10.4.3. Measuring temperature using NTC sensors.....	28
10.4.4. Readout of digital signals.....	29
10.4.5. Channel use in output mode.....	31
11. Operation through the control panel.....	33
11.1. Button functions.....	33
11.2. Menu operation.....	33
11.3. Menu structure.....	34
11.4. Menu functions and settings.....	35
11.4.1. Program.....	35
11.4.2. Settings.....	36
11.4.3. Users.....	37
11.4.4. Maintenance.....	38
11.4.5. L-Bus.....	39
12. Operating modes of external modules and their configuration.....	40
13. Operation through the AL Utility™ application.....	43
14. Maintenance and technical support.....	44
14.1. Servicing.....	44
14.2. Technical support.....	44
14.3. Disposal.....	44
15. References.....	45
15.1. Technical data.....	45
15.2. Compliance.....	45
15.3. Trademark and copyright.....	45
15.4. Licenses.....	45
15.5. Guarantees.....	45

1. Manufacturer details

The owner of the EDS CONTROLLERS® brand and manufacturer of devices under this brand is **eDev Studio sp. z o.o.** having its registered office in Olsztyn.

Registered address:

ul. Władysława Trylińskiego 2

10-683 Olsztyn, Poland

GLN Number: 5905359823001

Contact:

e-mail: info@edscontrollers.com

www.edscontrollers.com



Registration and administrative data:

Company registered at: District Court in Olsztyn, 8th Commercial Department - National Court Register (KRS)

KRS number: 000072265

Legal form: spółka z ograniczoną odpowiedzialnością (limited liability company)

EU VAT number: PL 7393913272

SISC/EORI ID number: PL739391327200000

BDO number: 000539363

2. Information legal

This user manual describes how to use the Ambity Line™ family of PLCs, also referred to as the device or devices. Before using the device, please read this manual carefully. If the device is used contrary to the instructions, the user shall be responsible for the resulting damage.

© 2023 eDev Studio sp. z o.o., ul. Trylińskiego 2, 10-683 Olsztyn, Poland. All rights reserved. Text, photos, graphics, software tools presented, as well as styling, are protected by copyright and other industrial property rights protection laws. The above provisions shall apply in particular to the trademarks EDS CONTROLLERS®, Ambity Line™, AL Utility™, other company logos and product logos. The documentation may contain content or trademarks copyrighted by third parties.

The contents of the documentation, without the permission of eDev Studio sp. z o.o. may not be copied, distributed, altered or made available to third parties for commercial purposes.

The information contained herein is subject to change without notice and does not constitute a commitment on the part of eDev Studio sp. z o.o.

Current versions of the documentation are available at <http://edscontrollers.com/support>.

3. Change log

Version document	Date of introduction	Location	Content of the amendment
1.0.0.	15.04.2023	Chap. 11.4, 11.5 and 12.	11.4 Update of menu structure for Settings, Maintenance, L-Bus 11.5 Updating, in the Settings, Maintenance, L-Bus submenu, added/changed functions and settings 12. Updating operating parameters in the Table of registers
-	-	-	-

4. Definitions, abbreviations and symbols

Definitions and abbreviations:

AL – a designation used with the Ambity Line™ family of products.

AL Utility™ – utility program for configuring and operating the system's devices.

Ambity Line™ – a family of modular PLCs.







COM – communication module (additional communication interfaces, e.g., CAN).

CPU – the system's central processing unit (may have a built-in I/O module), also referred to as the main unit in the documentation.

I/O – input/output module, also referred to as I/O module in the documentation.

Client program – a client program run by the CPU to perform the operations provided by the client.

System – CPU including modules.

Symbol	Meaning
	<p>Safety information for use.</p> <p>Failure to follow warnings or cautions marked with this symbol may cause an accident, damage or destruction of the device.</p>
	<p>Information that is particularly important for the correct operation of the device or application.</p> <p>Failure to follow recommendations or indications may result in an unintended condition or situation.</p>
	<p>Tips, useful information.</p>
	<p>Products covered by the WEEE directive. The marking indicates that the product should not be disposed of with municipal waste. Products with such a mark may contain hazardous elements and be harmful to health and the environment.</p> <p>Waste electrical and electronic equipment marked with this symbol should be collected separately. This type of waste requires a special form of processing, recovery, recycling and special disposal, which is handled by authorized specialized entities.</p>
	<p>Recycling symbol indicating that the product is recyclable. Packaging with this marking should be segregated and, depending on the material from which it is made, disposed of in the appropriate containers.</p>
	<p>Affixing the CE mark to a product confirms that it meets all the requirements of the New Approach Directives and the Regulations of the European Parliament and the Council on CE marking, and that a full conformity assessment process has been carried out.</p>

5. Safety



Basic requirements and safety of use

- The manufacturer shall not be liable for damages resulting from improper installation, failure to maintain in proper technical condition and use of the device contrary to its intended purpose.
- Installation of the device should be carried out by qualified personnel with the authorization required for the installation of electrical equipment. All local protection requirements must be considered during installation. It is the installer's responsibility to perform the installation in accordance with this manual and the safety and EMC regulations and standards appropriate to the type of installation being performed.
- Before use, the device should be configured (programmed) according to the required application. Incorrect configuration may cause erroneous operation leading to damage to the device or an accident.
- Adjacent and secondary equipment should meet the requirements of relevant safety standards and regulations, and (if necessary) be equipped with appropriate surge and interference filters.
- Systems built with this device may have dangerous voltage that can cause a fatal accident. It is imperative that the system be turned off by disconnecting the power source before installing or performing troubleshooting activities (in case of failure).
- If, as a result of a defect in the operation of the device, there is a risk of a serious threat to the safety of people and property, additional independent systems and solutions should be used to prevent such a threat.
- Do not attempt to disassemble, repair or modify the device yourself. The device has no user-replaceable components. Devices in which a defect is found must be disconnected and returned to an authorized service center for repair.
- The device should not be used in an explosive environment.
- The device should not be used in areas at risk of excessive shock, vibration, dust, moisture, corrosive gases and oils.
- The device should not be used in areas with large temperature fluctuations and subject to icing or condensation.
- The device should not be used in areas exposed to direct sunlight and infrared radiation.
- The device should be protected from precipitation and excessive moisture.
- Make sure that the ambient temperature of the device does not exceed the permissible values. In such cases, use forced cooling of the device.
- The device is designed for use in an industrial environment and should not be used in a residential or similar environment.



Exclusions and Prohibited Areas of Use

The devices are not intended for use with a voltage rating of between 50 and 1 000 V for alternating current and between 75 and 1 500 V for direct current, and are not intended for use as:

- Electrical equipment for use in an explosive atmosphere
- Electrical equipment for radiology and medical purposes
- Electrical parts for goods and passenger lifts
- Electricity meters
- Plugs and socket outlets for domestic use

- Electric fence controllers
- Radio-electrical interference
- Specialised electrical equipment, for use on ships, aircraft or railways, which complies with the safety provisions drawn up by international bodies in which the Member States participate
- Custom built evaluation kits destined for professionals to be used solely at research and development facilities for such purposes

6. System description

Ambity Line™ is a family of modular PLCs. The solution is designed for micro and small applications (up to a few dozen measurement inputs/outputs) and combines the advantages of compact and modular solutions. The central unit can be equipped with built-in I/O channels, in an amount that meets the needs of most small systems (objects of a concentrated nature, working on several measurement and control signals, such as mixers, fermenters, autoclaves, biochemical reactors, filter units, etc.). As needed, the system allows for free expansion by easily adding more expansion modules (up to 128 measurement inputs and control outputs in total).

The solution can be used in typical industrial applications (machinery, process lines, food and machinery industry, dryers, quality control systems), as well as in solutions related to technical and building infrastructure (e.g. transport systems, ventilation, dust removal, clean zones, lighting, boiler houses, heat and water supply nodes).

6.1. Modularity

The family is divided into 3 categories of modules:

- AL-CPU – central units (may have built-in input/output module)
- AL-IO – input/output modules (analog, digital, counter, timer, special)
- AL-COM – communication modules (additional communication interfaces, e.g., CAN)

The AL-CPU and AL-IO modules are mounted on a DIN rail. The AL-CPU allows up to 10 AL-IO modules to be connected and powered via special connectors mounted in a DIN rail recess. These connectors also form a communication bus for the Ambity Line™ system. Such a solution allows you to conveniently plug/unplug the module without disassembling the bus.

AL-COM modules are also DIN-rail mounted, but the communication and power bus is in the form of IDC (so-called ribbon) connectors.

The most important component of the system is the central processing unit (AL-CPU). Each system consists of exactly one AL-CPU and a number of AL-IO and AL-COM modules. The system can consist of the AL-CPU alone if the user only depends on the built-in communication interfaces (Modbus RTU and Ethernet).

The role of the AL-CPU is:

- execution of the user program
- communication with the AL-IO and AL-COM modules
- communication with other systems using available communication interfaces
- system management in general

The AL-CPU can be equipped with an internal I/O module, identical to the AL-IO category modules. Variants of possible AL-IO modules, available as CPU internal (embedded) modules, are listed in statements and specifications with an additional designation/suffix "i" (i = internal).

This compact design allows to reduce the cost of the system and implement simple projects, requiring basic communication interfaces and several I/Os, with a single device. Having an internal AL-IO module does not preclude attaching other modules to the CPU and easily expanding the system.

6.2. Systematics and nomenclature

Model nomenclature:

AL-(a)-(b).(c)(i)

AL – Ambity Line™

(a) – module category: CPU, IO, COM

(b) – group name

Defines the general characteristics of the modules belonging to the group.

For example:

AL-IO-A is a group of modules with non-isolated analog inputs (voltage, current), digital inputs and digital outputs.

(c) – number of the implementation variant

Determines the number of channels and functionality of individual channels.

For example:

AL-IO-A.10i – 8 channels, each fully configurable (voltage/current/digital inputs, digital outputs), internal module

AL-IO-A.36 – 12 channels (6 as current input only, 6 as digital output only), external module

(i) – the suffix "i" specifies whether it is an internal module (occurs as an additional designation for AL-IO modules internal – placed in the same enclosure with the CPU)

Description of the modules:

AL-CPU

Group:	Description:
M	Local User Interface (OLED 0.9", 6 buttons) 2x Modbus RTU, 1x Ethernet, 1x USB OTG, 1x microSD Program size up to 2 MB, data memory ~ 4 MB

AL-IO

Group:	Description:
A	Non-isolated analog-digital module Current analog inputs: nominal ranges 0-20mA Voltage analog inputs: nominal ranges 0-10V, 0-24V Digital inputs (realized as voltage measurement; it allows to set the threshold and hysteresis): nominal ranges 0-24V Digital outputs: OC (active low) 100mA

Summary of AL-CPU-M modules:

Model:	Modbus RTU (isolated)	Modbus RTU (non-isolated)	USB OTG	microSD	Ethernet	Local user interface
AL-CPU-M.1-x.yyi	1	1	1	1	1	YES
AL-CPU-M.2-x.yyi	-	1	1	1	1	YES

x.yy – group and variant of the built-in AL-IO module; x.yy = 0.00 means no built-in module.
Examples: AL-CPU-M.2-0.00i, AL-CPU-M.2-A.10i.

Each AL-CPU comes standard with:

- local user interface (OLED display, buttons)
- 1x interface for communication with AL-IO modules
- 1x USB OTG (communication with the AL Utility™ program; support for USB flash drives)
- 1x microSD (file sharing memory; process data logging memory¹)
- 1x Ethernet (TCP/IP; for communication with AL Utility™²)
- 1x Modbus RTU (master/slave) non-isolated

AL-CPU can be additionally equipped with:

- 1x Modbus RTU (master/slave) isolated

¹ Functionality currently unavailable. It will be added in the future.

² Future expansion with additional industrial protocols, e.g., Modbus TCP.

Summary of AL-IO-A modules:

Model:	variant "i"	Total number of channels	Universal			Dedicated			
			AI/DI/ DO	AI/DI	DI/DO	AI (DI) (voltage)	AI (current)	DI	DO
AL-IO-A.10	YES	8	8						
AL-IO-A.11	YES	8		8					
AL-IO-A.12	YES	8				8			
AL-IO-A.13	YES	8					8		
AL-IO-A.14	YES	8		4					4
AL-IO-A.15	YES	8				4			4
AL-IO-A.16	YES	8					4		4
AL-IO-A.17	YES	8			8				
AL-IO-A.18	YES	8							8
AL-IO-A.19	YES	8						8	
AL-IO-A.30	NO	12	12						
AL-IO-A.31	NO	12		12					
AL-IO-A.32	NO	12				12			
AL-IO-A.33	NO	12					12		
AL-IO-A.34	NO	12		6					6
AL-IO-A.35	NO	12				6			6
AL-IO-A.36	NO	12					6		6
AL-IO-A.37	NO	12			12				
AL-IO-A.38	NO	12							12
AL-IO-A.39	NO	12						12	

Table: number and types of signals in a particular device model.

Legend:

Universal (U), means that a channel can be set to measure at least 2 different types of signals, such as current or voltage.

- AI/DI/DO – analog inputs (voltage or current) or digital inputs and outputs
- AI/DI – analog inputs (voltage or current) or digital inputs
- DI/DO – digital inputs and outputs

Dedicated, means that a channel is specialized to measure a specific type of signal, such as current, while voltage channels can always serve as a digital input.

- AI (DI) (voltage) – analog inputs (voltage only) or digital inputs; (DI) means that it can be used as a digital input
- AI (current) – analog inputs (current only)
- DI – digital inputs
- DO – digital outputs

Operating ranges:

- AI (DI) (voltage): nominal ranges 0-10V, 0-24V
- AI (current): nominal range 0-20mA
- DI (realized as voltage measurement; this allows you to set the threshold and hysteresis): nominal range 0-24V
- DO: OC (active low) 100mA

"i" – the module is also available as an internal AL-IO module (suffix "i"; for example AL-IO-A.10◇AL-CPU-M.1-A.10i)

The difference between the variant containing the AI (DI), used for digital inputs, and the variant containing the DI alone, is that the AI (DI) has precise and calibrated components to accurately measure the voltage signal. The variant with DI alone has only rough accuracy (a few percent).

6.3. Configurable I/O channels

A distinguishing feature of the Ambity Line™ family is that it has AL-IO modules with configurable channels. Configurable channels, unlike dedicated channels, can operate in different modes – depending on your needs, it can be a current or voltage input, as well as a digital input or output. It is a kind of universal input/output channel.

In the AL-IO-A group of input/output modules (analog current or voltage input and digital input/output modules), you can find variants in which all channels are configurable in the full range of types available for the other modules. Such a module can replace any other variant from the same product group (AL-IO-A). With this approach, a user who has built a system from modules with dedicated channels (lower start-up cost of the installation) does not need to have a large number of modules in case of failure (typically at least one spare piece of each module variant). It is enough to have one or two pieces of modules with fully configurable channels. This way, in case of failure, the maintenance engineer will have a suitable backup module. This approach reduces the risk of downtime, shortens repair times, and at the same time significantly reduces expenditures on spare parts inventory.

7. General characteristics of the CPU

7.1. General view and description of parts



Models depending on the variant design may differ in appearance. The visualization shown is for the variant with all interfaces and built-in measurement modules.

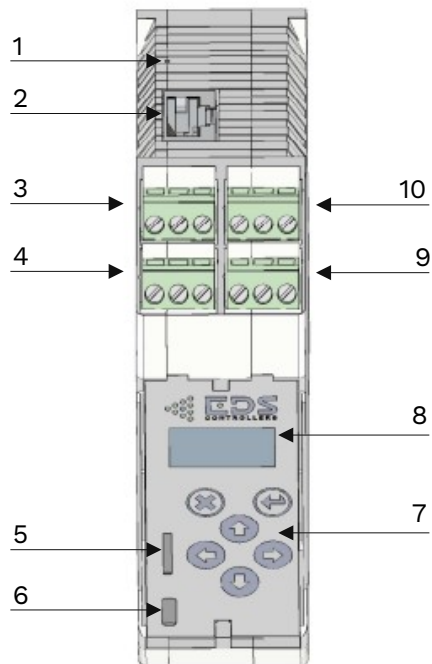

- 1 Factory reset button
- 2 Ethernet connector
- 3 Modbus connector 1 (not isolated)
- 4 Modbus connector 2 (isolated) – occurs in the M.1 version of the design.
- 5 MicroSD card slot
- 6 USB-OTG socket (micro AB)
- 7 Local keyboard
- 8 Local display (OLED 128x64)
- 9 Connector for channels 1-2 of the built-in I/O module
- 10 Connector of channels 5-6 of the built-in I/O module

Items 9-10 are not present in models without built-in I/O module

Fig. 1. View of the main unit front from above

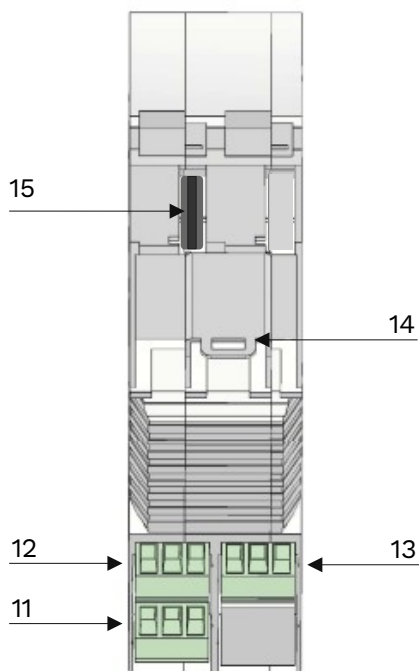

- 11 Connector of channels 3-4 of the built-in I/O module
- 12 Connector for channels 7-8 of the built-in I/O module

Items 11-12 are not present in models without built-in I/O module

- 13 Power connector
- 14 DIN rail latch
- 15 DIN rail bus connector

Fig. 2. View of the main unit rear view from below

7.2. Technical data

Power supply:

Voltage	22..24..26 VDC
Power consumption	Typically 150mA @24V (max. 250mA)
Power source	External stabilized power supply
Protection against change of polarity	YES
Internal overload protection	YES (1.5A)
Emergency power supply	YES – external 12V 1.2Ah battery; built-in charger Charging at 150mA when power supply is in normal range

Processor, memory, performance:

Processor	ARM Cortex-M7 200MHz
User program size	Up to 2 MB Stored in the internal file system
User data memory	128 kB MCU SRAM (fast; only stack and program data) 4 MB SDRAM (shared between code and data)
RETAIN data size	0.25 MB (saved to the internal file system when the user program is stopped and restored when the user program is started)
Supported number of inputs/outputs	It results from the modules used. The CPU allows you to connect up to 10 I/O modules, obtaining up to 128 supported I/O (built-in 8-channel I/O + 10x external 12-channel module)
Configurable program cycle time	50..1000ms

Interfaces:

Modbus RTU isolated (comes in the M.1 version of performance)	Operating modes: master, slave Transmission speed: 1200, 2400, 4800, 9600, 19200, 38400, 57600, 115200 Insulation strength: Basic insulation; Vmax 560Vrms; Test voltage 2500Vrms@1min
Modbus RTU non-isolated	Operating modes: master, slave Transmission speed: 1200, 2400, 4800, 9600, 19200, 38400, 57600, 115200
Ethernet	10/100 Base-T
Local user interface	OLED display 128x64 pixels, monochrome white 6 buttons
USB-OTG	MicroUSB slot type In HOST mode: USB memory support (data transfer from to AL-CPU); supported formats: FAT32 In DEVICE mode: communication with the computer (AL Utility™ program)
microSD	Support for a memory card for data recording and data transfer from/to AL-CPU Supported formats: FAT32
AL-IO-bus	System bus for communication with AL-IO modules (RS-485 with dedicated communication protocol)

Measurement and control:

Number of channels	0 or 8 (depending on the implementation variant)
Signal type	Depending on the implementation variant, the type and range of measurement for the CPU is the same as the specifications of AL-IO modules corresponding to them (example: AL-CPU-M.1-A.10i → AL-IO-10)

Installation:

Type of installation	DIN rail, Type O, 35 mm
Mounting method	Built-in latches (apply-and-press type), no need for

Replacement or expansion	additional brackets or adapters
Combining modules	Directly on the DIN rail Using a bus connector, forming a communication and power bus, installed inside the DIN rail (no wiring required)

Housing:

Degree of protection	IP 20/DIN EN 60529
Fabrication material	Polyamide (PA66)
Flammability and fire safety class	UL 94 V0
Color	Light gray RAL 7035 (green plugs)
Dimensions (without plugs)	35 x 99 x 114.5 mm (W x H x D)
Dimensions (with plugs)	35 x 109 x 114.5 mm (W x H x D)

Input/output terminals:

Type	Terminal block detachable, screw connectors, single-section
Raster	5.0 mm
Ø hole / cable dimensions	max. power cable cross-section 2.5 mm ² / max. cable diameter 2.0 mm
Insulation stripping length	7 mm
Screw type	M3

Conditions of use:

Temp. range	0... +55°C
Humidity	85% max.

Transportation and storage:

Temp. range	-20... +70°C
Humidity	85% max.
Unit packaging	Cut cardboard box
Number of pieces per package	1
Package dimensions	118 x 80 x 140 mm (W x H x D)
Country of origin	PL

Compliance/certifications:

CE mark	YES
RoHS rating	YES
REACH Assessment	YES

8. General characteristics of I/O modules

8.1. General view and description of parts



Models depending on the variant design may differ in appearance. The visualization shown is for the 12-channel module variant.

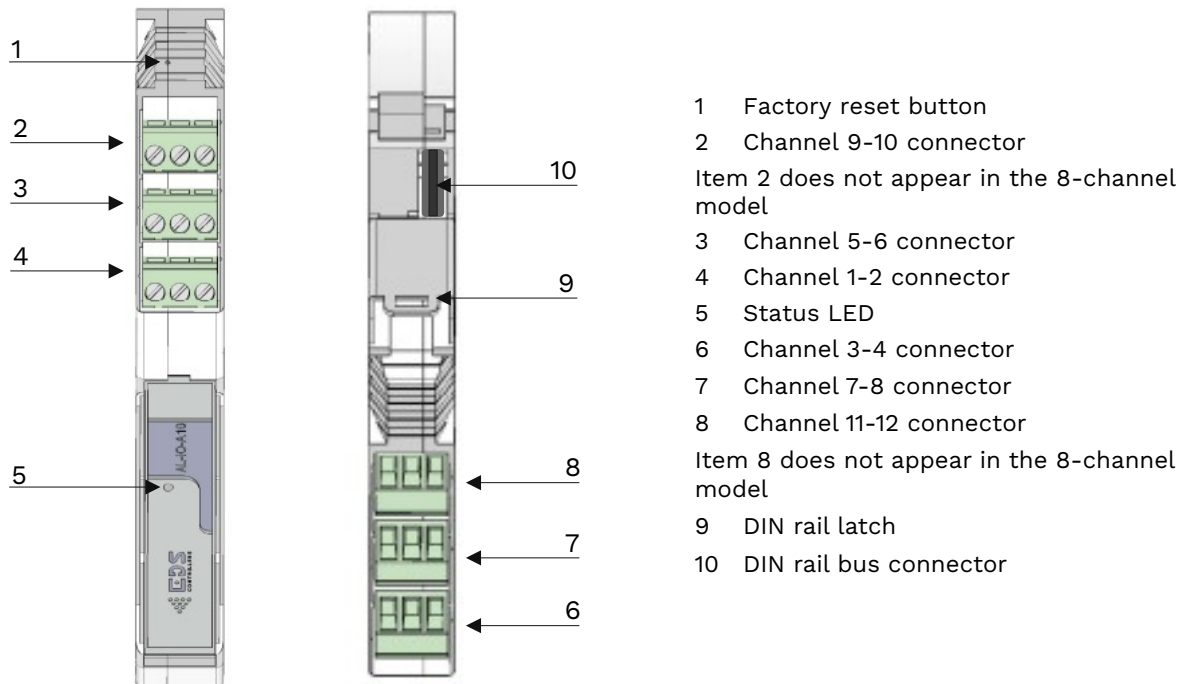

Fig. 3. View of the 12-channel module (left front from the top, right back from the bottom)

8.2. Technical data

Power supply:

Voltage	22..24..26 VDC
Power consumption	Typically 25mA @24V (max. 50mA)
Power source	From the system bus
Protection against change of polarity	YES
Internal overload protection	YES (100mA)

Communication:

Interface type	AL-IO-bus – System bus for communication with AL-IO modules (RS-485 with dedicated communication protocol)
----------------	--

Measurement and control:

Number of channels	8 or 12 (depending on the implementation variant)
--------------------	---

Signal type	Depending on the design variant, according to the list of AL-IO modules
Galvanic isolation from the system	NO
Galvanic isolation between channels	NO
Measurement speed	min. 10 measurements per second (each channel)
Current inputs:	
ranges of work	0-20mA (max. 0-24mA)
input impedance	~100 Ohms
accuracy	0.15% of the nominal range
temp. stability	0.01%/°C
overcurrent protection	YES
protection against change of polarity	NO (changing the polarity risks damaging the channel)
Voltage inputs:	
ranges of work	0-10V (max. 0-11V) 0-24V (max. 0-28V)
input impedance	~100 kOhm
accuracy	0.15% of the nominal range
temp. stability	0.01%/°C
protection against change of polarity	NO (changing the polarity risks damaging the channel)
Digital input (realized as voltage measurement):	
ranges of work	0-24 V
input impedance	~100 kOhm
accuracy	5% of the nominal range
protection against change of polarity	NO (changing the polarity risks damaging the channel)
Digital outputs:	
type	OC (active low) (N-MOSFET transistor)
maximum voltage	30V
maximum current	100mA
impedance in the open state	~100 kOhm
impedance in the short-circuit state	~5 Ohms
overload protection	YES (100 mA)
protection against change of polarity	NO (changing the polarity risks damaging the channel)

Installation:

Type of installation	DIN rail, Type O, 35 mm
Mounting method	Built-in latches (apply-and-press type), no need for additional brackets or adapters
Replacement or expansion	Directly on the DIN rail
Combining modules	Using a bus connector, forming a communication and power bus, installed inside the DIN rail (no wiring required)

Housing:

Degree of protection	IP 20/DIN EN 60529
Fabrication material	Polyamide (PA66 FRIANYL® A3 RV0)
Flammability and fire safety class	UL 94 V0
Color	Light gray RAL 7035 (green plugs)
Dimensions (without plugs)	17.5 x 99 x 114.5 mm (W x H x D)
Dimensions (with plugs)	17.5 x 109 x 114.5 mm (W x H x D)

Input/output terminals:

Type	Terminal block detachable, screw connectors, single-section
Raster	5.0 mm
Ø hole / cable dimensions	max. power cable cross-section 2.5 mm ² / max. cable diameter 2.0 mm
Insulation stripping length	7 mm
Screw type	M3

Conditions of use:

Temp. range	0... +55°C
-------------	------------

Humidity	85% max.
----------	----------

Transportation and storage:

Temp. range	-20... +70°C
Humidity	85% max.
Unit packaging	Cut cardboard box
Number of pieces per package	1
Package dimensions	118 x 80 x 140 mm (W x H x D)
Country of origin	PL

Compliance/certifications:

CE mark	YES
RoHS rating	YES
REACH Assessment	YES

9. First steps

9.1. Preparing for installation



After removing the device from its packaging, check its technical condition, paying particular attention to mechanical damage, including any cracks or cavities in the housing, broken or bent connector leads, as well as any small objects moving freely inside or falling out of the device. It is forbidden to use a defective device, and if any defect or abnormality is found, stop using the device and contact the dealer.

The package includes the device, plugs, a bus connector for connecting modules, a quick guide.

The plugs can be inserted into the device both before DIN-rail mounting and after mounting (depending on the needs and subsequent convenient access to the device and wiring).

The front of the device is protected by a transparent protective flap. The flap is tilted from the bottom (the hinge of the flap is at the top).

9.2. Rail mounting, bus, interconnection of modules



- **All connections should be made with the power supply off.**



- For the correct operation of the bus, it is necessary to connect all lines.
- It is not allowed to connect devices other than Ambity Line™ to the bus, any external power sources and/or receivers, as well as to terminate the communication bus in any other way than recommended by the manufacturer.
- The installation should take into account the environment and operating conditions specified for the device in the specifications.

Ambity Line™ series units are designed for DIN-rail mounting. The rear of the rebuild has the appropriate hooks and latches for proper mounting.

In the rear part of the casing there are cut-outs enabling access to the contacts of the communication bus (installed in the DIN rail, see: figure 2 item 15 and figure 3 item 10) - to contact pads on the PCB. The communication bus allows the expansion of the main unit with additional I/O modules, providing their power and data transmission. A single main unit can be extended by up to 10 modules, which allows for a total of 128 measurement inputs and control outputs.

Easy installation and expansion of the system is facilitated by built-in latches (apply-and-press type), without the need for additional brackets or adapters. Mounting, replacement or expansion can be done directly on the DIN rail. The individual modules are connected by a bus connector, forming a communication and power bus, installed inside the DIN rail (no wiring required).

All inputs and outputs are equipped with detachable terminal blocks.

The housing is made of high-quality polyamide PA66, characterized by high mechanical and physical resistance, while maintaining flexibility, which reduces the risk of damage to the product during installation.



Installation of the bus connector

If the system configuration provides for external I/O modules or further expansion, the first step of installation is to plug in the DIN rail bus connector (the connector is included in the kit), as shown in Figure 4. For the connection of the main unit to the external I/O module, we use 2 bus connectors (one attached to the main unit, the other to the I/O module - both connectors are the same, they can be used interchangeably). The connectors slide into each

other.

We expand the system in I/O modules from left to right looking from the front of the set (main unit, then external I/O modules).

Then we assemble the individual devices of the system, plugging them into the prepared bus connectors. The bus connectors should be plugged into the cutouts visible in the rear of the case (see Figure 2 item 15 and Figure 3 item 10).

If the main unit will not be expanded with external I/O modules, the main unit is mounted directly on the DIN rail, bypassing the bus connector.

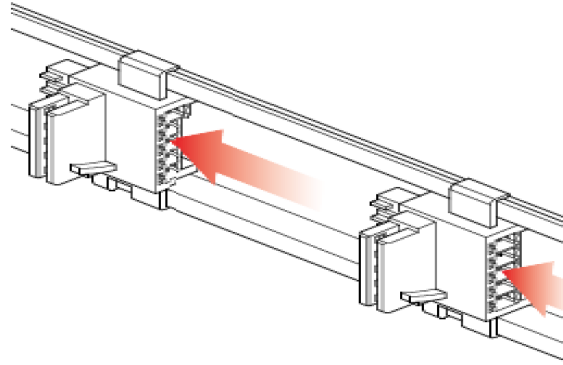

Fig. 4. Installation of bus connector in DIN rail



Installation of modules

Apply the device to the DIN rail at an angle so that the top edge of the DIN rail is hooked through the plastic clip on the device. The device should be pressed against the DIN rail, so that the metal latch automatically encircles the bottom edge of the DIN rail (the bus connector plugs into the device automatically).

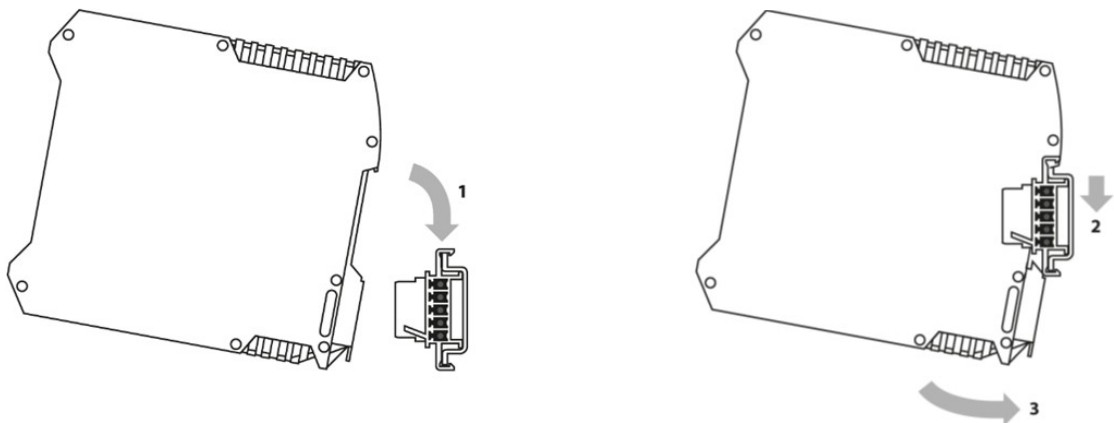

Fig. 5. DIN rail mounting of modules



Disassembly of modules

To disassemble the device, turn off the power and disconnect the connections to the input/output terminals (plugs), if connected. To remove the device from the DIN rail, pull back the metal latch (insert, preferably with a flathead screwdriver, into the locking eyelet and pull it down).

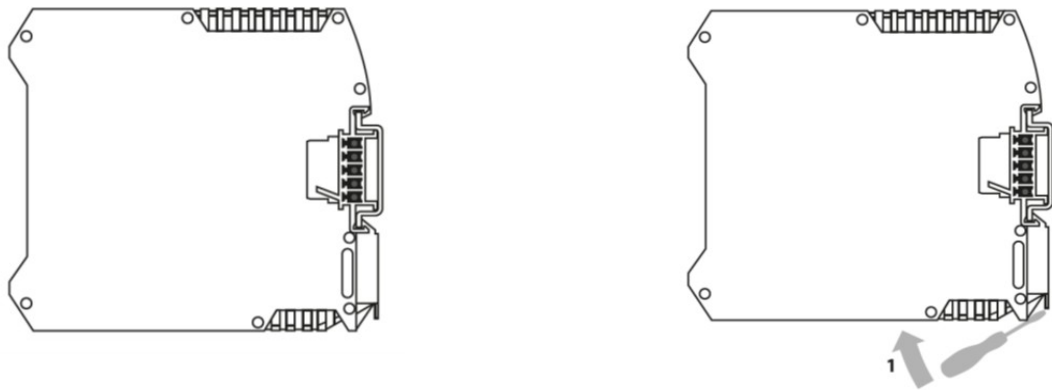

Fig. 6. Disassembly modules on DIN rail



Installation and removal of plugs

- To install the plug, insert it into the socket and press it down.
- To remove the plug, insert a flathead screwdriver into the hole of the locking eyelet, and then the loosened plug, gently pull out of the socket.



- In the center of the plug, just above the plug's exit from the housing, is a terminal locking eyelet hole for easy removal.



Cabling

- The electrical installation of the system should be carried out by suitably qualified persons.
- The proper routing of the cables and the way they are spliced are important to minimize the risk of interference and crosstalk, and to avoid short circuits between signals and other hard-to-detect damage.
- For the best possible result, it is recommended to use sleeves at the ends of the connection wires with a diameter that matches the cross section of the wire.
- If you need to connect 2 or more wires in one terminal, use a sleeve with a larger diameter, with a properly shaped cover.
- To avoid the risk of electrochemical corrosion, it is advisable to avoid tin plating on the ends of wires attached to terminals.



- \varnothing hole / cable dimensions: max. power cable cross-section 2.5 mm²/ max. cable diameter 2.0 mm
- Insulation stripping length: 7 mm
- Screw type: M3
- Max. torque when tightening screw connectors 0.5 Nm

Figure 7 shows the recommended way to prepare the cables, its length and the maximum diameter that can be used in the device.

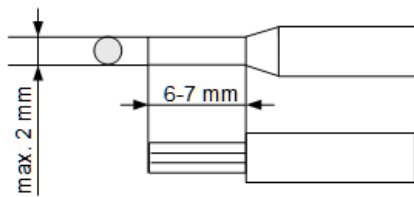

Fig. 7. The method of sealing the wires before their installation in the connection plugs

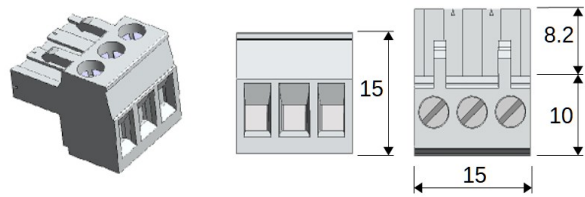

Fig. 8. General view and dimensions of the plugs

9.3. Connecting the power supply and battery



All modules of the Ambity Line™ series are equipped with an additional contact to ensure that they are securely connected to the PE line via the DIN rail. When installing the DIN rail in a metal cabinet, ensure that the entire cabinet and the rail are properly grounded. When installing the DIN rail on a non-conductive substrate (e.g., in a distribution box made of plastic), it is necessary to ensure that the DIN rail is properly grounded by making a dedicated connection to the PE line with a wire of the appropriate cross-section.

The device's power connector is located at the bottom of the housing on its left side (see Figure 2, item 13). Although the main unit is protected against reverse polarity of the power supply, care should be taken to connect it properly, because in some cases there may be accidental activation of the controlled object, the measuring transducer may be damaged, and even the I/O path in the I/O module may be damaged as a result. The basic type of power supply is a 24V DC power supply. The current capacity of the power supply should be selected according to the number and type of I/O modules used in the system. The expected maximum load of the power supply should be calculated by adding up the consumption of all loads supplied from this power supply.

According to the technical parameters for the main unit, assume a maximum consumption of 250mA and, for simplicity, 100mA for each external I/O module (although they can typically consume less current). So, in total, for a system consisting of a main unit and 10 external I/O modules, the maximum consumption can be 1.25A (not counting the power supply of current outputs).

It is good practice to use a power supply with a minimum 10% reserve of current capacity in relation to the calculated sum of all loads. Thus, to power a system with 10 external I/O modules, it is recommended to adopt a power supply with a capacity of at least 1.5A (not counting the current required for current outputs).

When supplying passive current outputs from the same source, assume a consumption of 25mA per output. So, powering 20 current outputs requires at least 0.5A of power supply capacity.

The power supply of signaling devices, external relays and contactors requires an individual approach and analysis of parameters based on the data provided by their manufacturers.



- The transducers, current outputs, signaling systems and actuators installed in the system must not be powered directly from the battery or from the BAT+ terminal of the main unit, as this may damage these components and the battery.

The power supply connection of the main unit should be made according to the diagram shown in Figure 9.

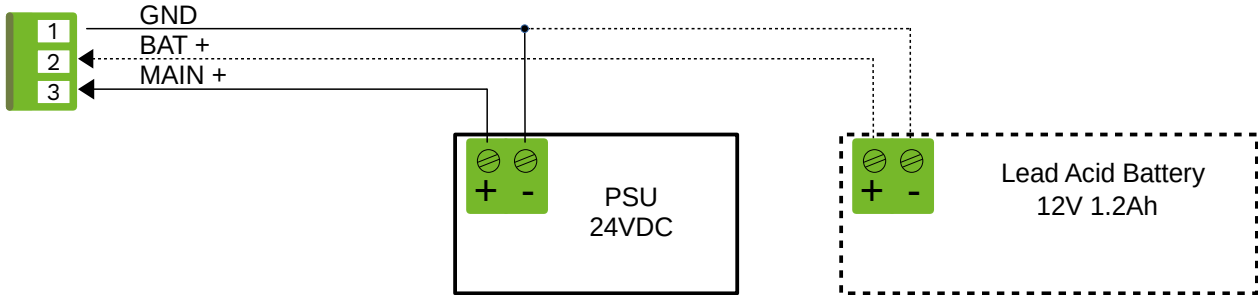

Fig. 9. Power supply wiring diagram and battery (not required)

The main units have a separate circuit for connecting an emergency power source in the form of an external 12V 1.2Ah acid battery and a built-in 100mA constant-voltage (13.6V) charger circuit. The connection of a battery is not required for proper operation of the system, and if it is used, it should be done according to the diagram shown in Figure 9.

The emergency power supply in its basic function allows one, at the time of loss of the main power supply, to safely stop the system, record the operating parameters and status of the controlled object, and send appropriate notifications to the master system, e.g., via the Ethernet interface. The emergency power supply is also provided to the I/O modules allowing their uninterrupted communication with the main unit.

9.4. RS-485 (Modbus RTU) Buses

The main units are equipped with 1 or 2 built-in RS-485 interfaces transmitting data using the Modbus RTU protocol. Interface number MB1 is not galvanically isolated, and its GND line is at the same potential as the power supply ground. Interface number MB2, available only in M.1 CPU variants, has galvanic isolation. Both interfaces can operate in both MASTER and SLAVE modes.

The parameters of the data link layer (baud rate, data word length, number of start and stop bits, parity type), as well as the basic parameters of the network layer (M/S mode, address, timeout and number of repeats), can be set from the main menu of the main unit. However, the set of Modbus registers available for writing/reading, as well as their parameters, should be defined in the user program.

The basic way to connect the main unit to other devices via the RS-485 interface is shown in Figure 10. It is recommended to use a shielded twisted-pair cable (shielded TP) with a wave impedance of about 100 ohms to make the connections. This recommendation is especially important for data transmission at higher speeds. It is recommended to use terminating resistors (120 ohms) at both ends of the network for best performance when making connections. When networking more than 2 devices, apply the general recommendations for the RS-485 interface, in particular, maintain a linear architecture without branches.

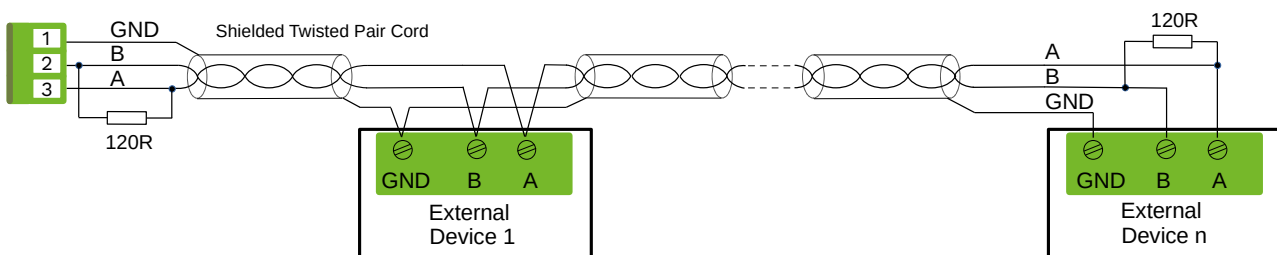

Fig. 10. Connection diagram CPU with external devices via the RS-485 interface

9.5. Connecting to a computer

CPU can be connected to a computer in several ways, with varying read, write or configuration options obtained depending on the type of interface used for communication, as shown in the comparison table below.

Interface type	Read/Write data provided by user program	View current measurement values and hardware settings of all channels in I/O modules	Read/Write user program from/to external USB memory stick	Full configuration
Ethernet link	YES	YES	-	YES
USB link	-	YES	YES	YES
RS-485 link	YES	-	-	-

In order to configure the device (e.g. load the user program and verify the operation of I/O modules), it is best to connect the device to a PC using an Ethernet connection.

At the factory, the new device is set to the mode of assigning an IP address via the DHCP protocol. In this case, immediately after starting the device, the local display will show "DHCP IP: 0.0.0.0". In this case, when the runninghead unit is connected to a LAN with a router on which DHCP service is available without MAC address filtering, the IP address will be assigned automatically. About 4-5 seconds after connection, the local display of the main unit will show the IP address assigned to it (e.g., "IP: 192.168.1.103").

If you can't connect the main unit to the local network with DHCP or need to connect it directly to a PC, you can manually configure the Ethernet interface settings on the unit. To do this, enter the configuration menu by pressing the ENTER↵ key, using the direction buttons select Settings, then Network (see: chapter 11, point 11.4.2.). Before making changes to the settings, it is recommended that you consult the scope of the changes with your local network administrator so as not to disrupt its operation.

If, immediately after the power is turned on, the local display shows a message, e.g.: "STATIC IP: 188.123. 1.1", this means that a manual setting of the Ethernet interface parameters has been made. Before continuing work, make sure that the current Ethernet interface settings allow it to operate on the available local network. In particular, check the subnet mask. If necessary, change the settings, but it is recommended to first consult with the local network administrator in this regard, so as not to cause disruption.

An example of Ethernet interface settings to ensure proper connection to a static LAN or directly to a PC might be as follows:

```
DHCP : OFF
IP:192.168.0.10
SUBNET: 255.255.255.0
GATEWAY: 0.0.0.0
```

Knowing the current IP address of the main unit controller, you can set up an active connection in the AL Utility™ utility program. Details on the use of AL Utility™ are described in Chapter 13.

To configure the device in an office environment, the easiest way is to use the USB interface. Such a connection does not require configuring any settings on the controller side. Due to the location of the USB connector on the front of the device, this method of connection is also recommended when it is necessary to configure a device already installed in the system, where access to the Ethernet connector is limited or impossible, or when it is not possible to connect the service computer to the LAN on which the controller of interest to the service technician operates.

For safety, it is recommended that, where possible, the connected computer be powered from the same phase of the power grid as the controller. In the case of a laptop, it can run on a built-

in battery. This approach eliminates the risk of damage to the USB ports on the computer and controller, resulting from differences in ground potentials in the absence of a computer connection to the PE line.

In order to set up a connection using the USB port, the already running main unit driver should be connected to the computer using a USB A - microB cable that meets the requirements of the USB version 2.0 interface.

When the main unit controller is connected to a particular computer for the first time, it may be necessary to install the appropriate VCP port drivers. This may affect computers with operating systems older than Windows 10. The drivers can be downloaded from the website <http://edscontrollers.com/drivers-download>.

Using the USB interface to set up an active connection with the main unit controller, select the appropriate COM port in the AL Utility™ service program. Details on the use of AL Utility™ are described in Chapter 13.

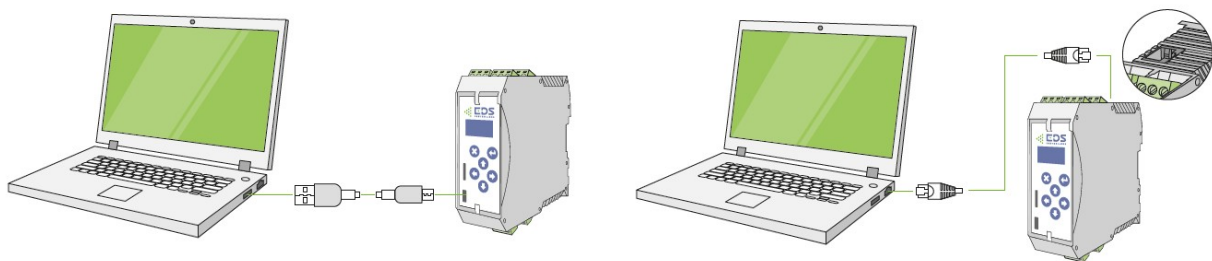

Fig. 11. Controller connection via USB and Ethernet directly to a PC

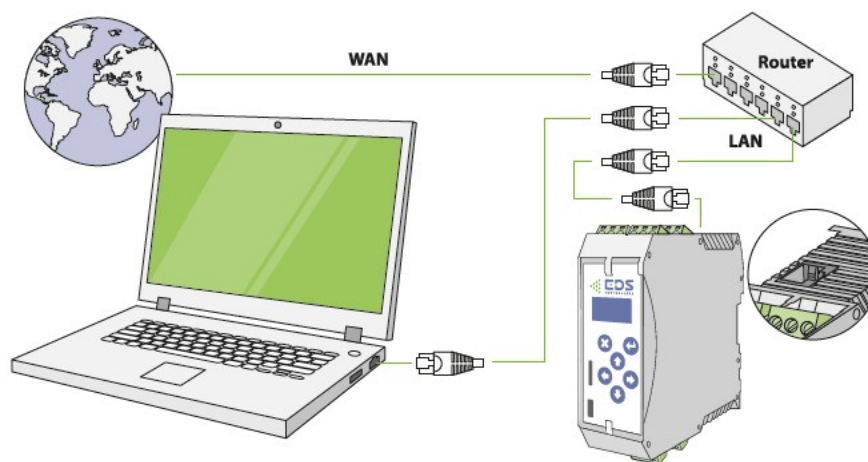

Fig. 12. LAN connection of the controller

10. Method and wiring diagrams

10.1. Types and description of connectors in the CPU module



When making connections, pay attention to the numbering of the pins in the plugs. The following visualizations show the layout of the plug after removing/before inserting it into the top or bottom socket on the device.

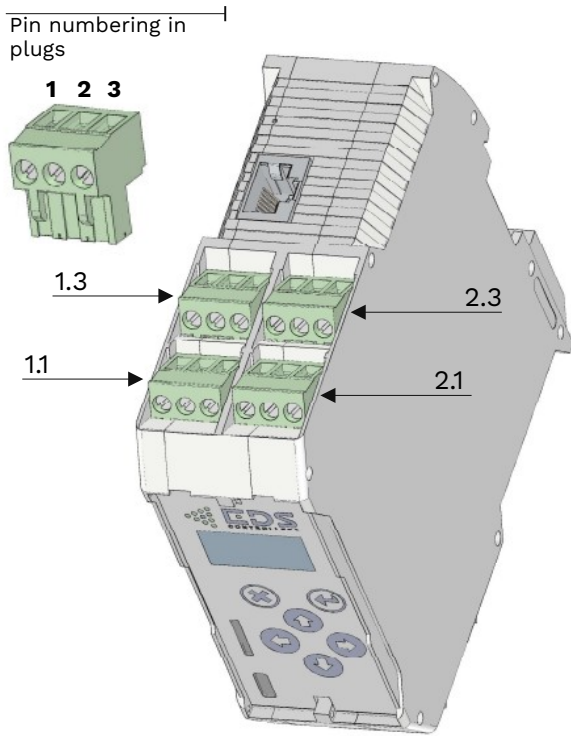

Fig. 13. Pin numbering of the main unit (located from the top)

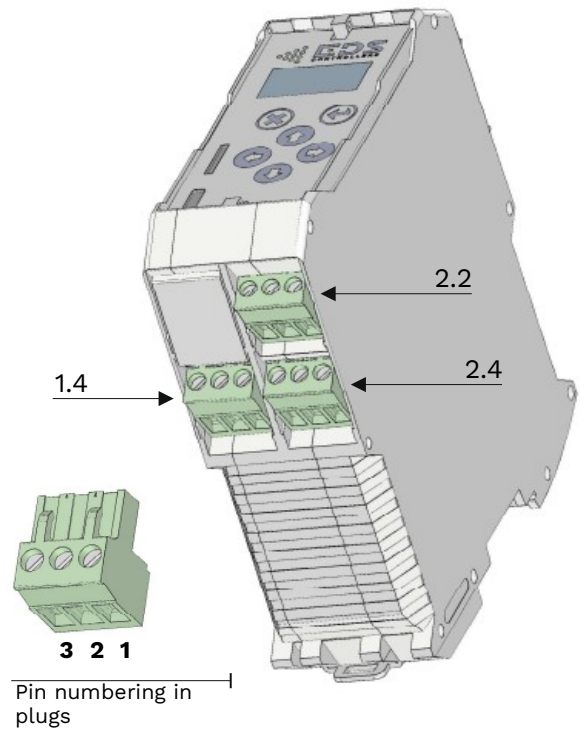

Fig. 14. Pin numbering of the main unit (located from the bottom)

1.1 Modbus (isolated) - MB2 (only in M.1 version units)	
1.2 Unassembled	
1.3 Modbus (non-isolated) - MB1	
1.4 Power supply	

Fig. 15. Terminal blocks of the main unit (marked 1.X are used to connect to interfaces)



2.1 I/O module channels 1 & 2	
2.2 I/O module channels 3 & 4	
2.3 I/O module channels 5 & 6	
2.4 I/O module channels 7 & 8	

Fig. 16. Terminal blocks of the main unit (marked 2.X are used to connect the I/O channels of the built-in I/O module)

10.2. Types and description of connectors in I/O modules

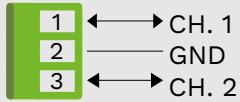
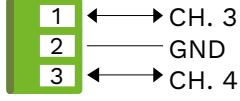

When making connections, pay attention to the numbering of the pins in the plugs. The following visualizations show the layout of the plug after removing/before inserting it into the top or bottom socket on the device.

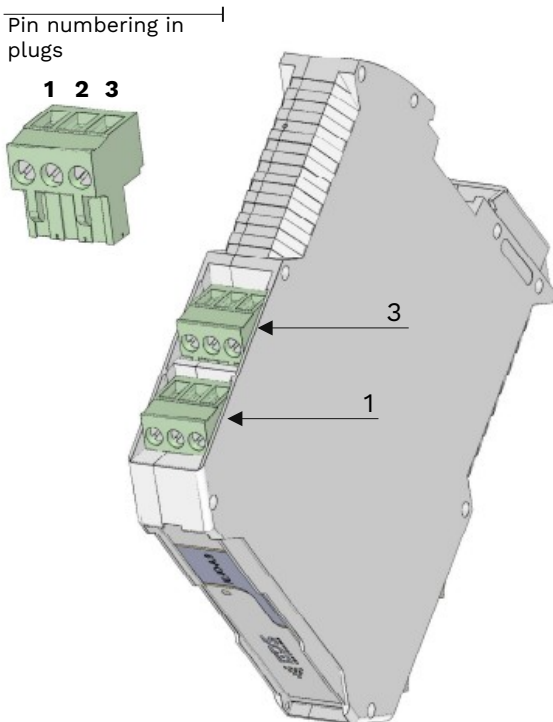

Fig. 17. 8-channel I/O module pin numbering (located from the top)

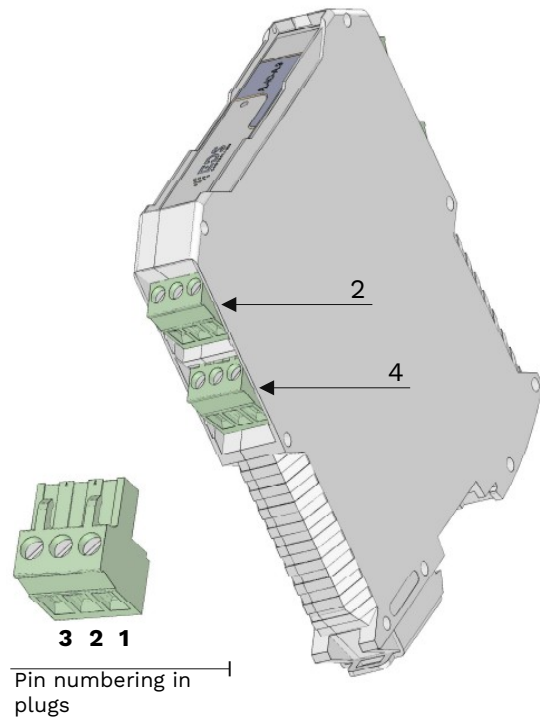

Fig. 18. 8-channel I/O module pin numbering (located from the bottom)

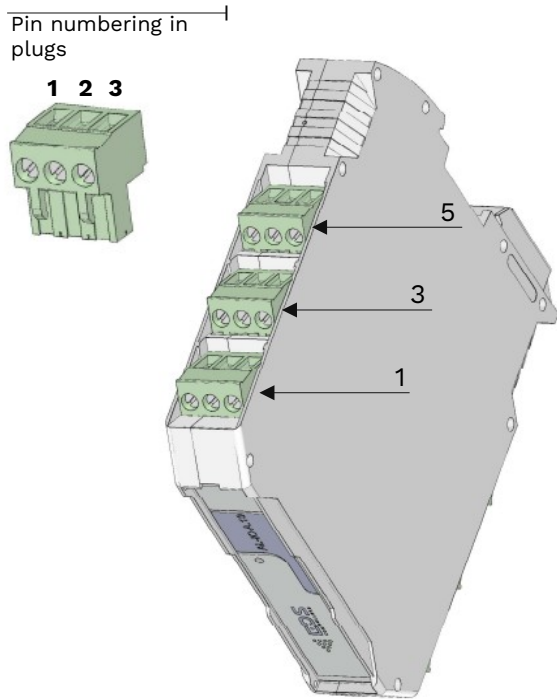

Fig. 19. 12-channel I/O module pin numbering (located from the top)

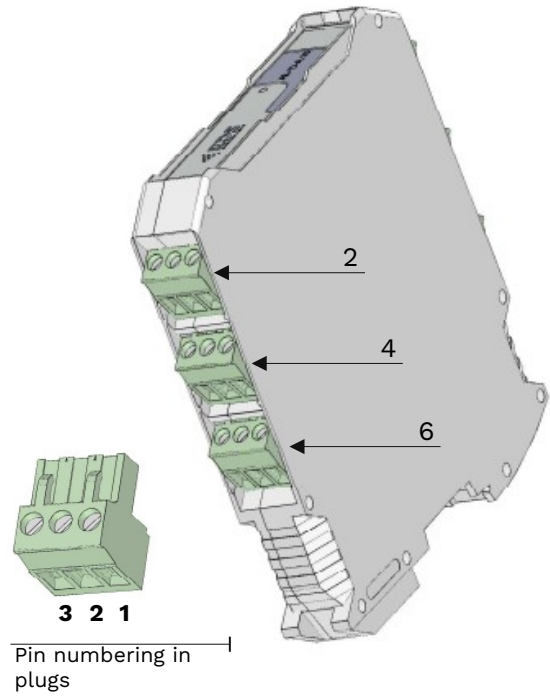

Fig. 20. 12-channel I/O module pin numbering (located from the bottom)

1 I/O module channels 1 & 2	
2 I/O module channels 3 & 4	
3 I/O module channels 5 & 6	
4 I/O module channels 7 & 8	
5 I/O module channels 9 & 10 (only in 12-channel modules)	
6 I/O module channels 11 & 12 (only in 12-channel modules)	

Fig. 21. Terminal blocks for external input/output modules

10.3. Restrictions and warnings – improper use of in and out channels



Voltage inputs should not be connected to signals with a voltage higher than 30V. For measurement accuracy, the output resistance of the source should be less than 1kOhm (except for temperature measurements using NTC sensors).

Current inputs should not be connected directly to voltage (power) sources. The input current flowing into the current input should not exceed 30mA, and the voltage of the source supplying the measuring circuit should not be higher than 30V.

The maximum continuous current for OC outputs is 120mA. The outputs have 120mA polymer fuse protection, but the momentary current can reach 250mA (up to about 10ms) - prolonged loading of the output with such a current will open the built-in fuse. The maximum voltage in the OC output circuit should not exceed 30V. Values higher than this can damage the output circuits. In the case of controlling inductive loads, protection is required to ensure that the OC output voltage is limited to 30V.

10.4. Examples of connecting signals/sensors

10.4.1. Current measurement 0/4-20mA

In order to use the channel to measure 0/4-20mA current signals, the selected channel should be switched to 0-20mA current measurement mode. Configuration is done at the user program level in the system's main unit. The method of connecting loop-powered (2-wire) transmitters with 4-20mA current output is shown in Figure 22.

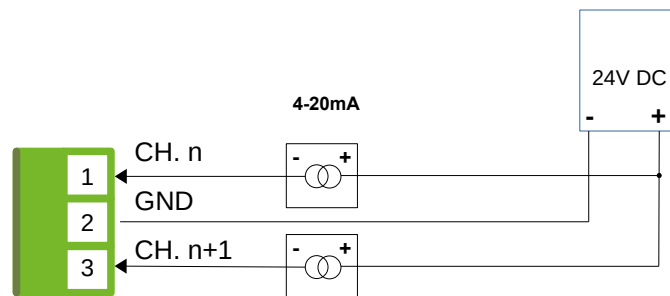

Fig. 22. Connection of 2-wire transmitters with current output

Transmitters with a separate power supply circuit (3-wire) require an additional GND line connection. A diagram of their connection to the measurement inputs is shown in Figure 23.

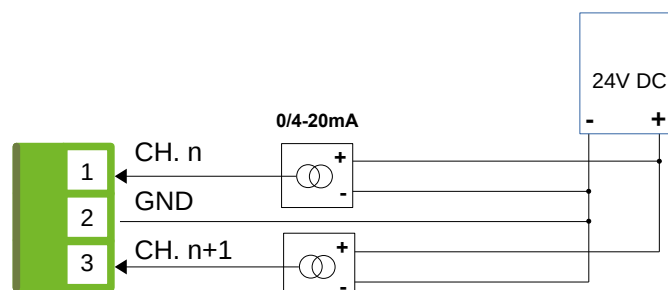

Fig. 23. Connection of 3-wire transmitters with current output

10.4.2. Voltage measurement 0-10/24V

In order to use the selected channel for 0-10/24V voltage measurement, it should be configured into voltage measurement mode with a range as close as possible to the measured values. Mode configuration is done at the user program level in the system's main unit. Transducers with voltage output have a separate power supply circuit, and the way they are connected is shown in Figure 24.

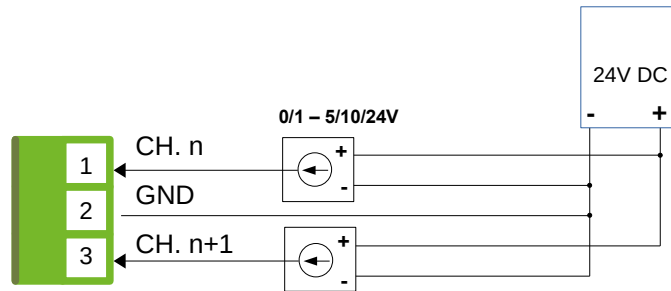
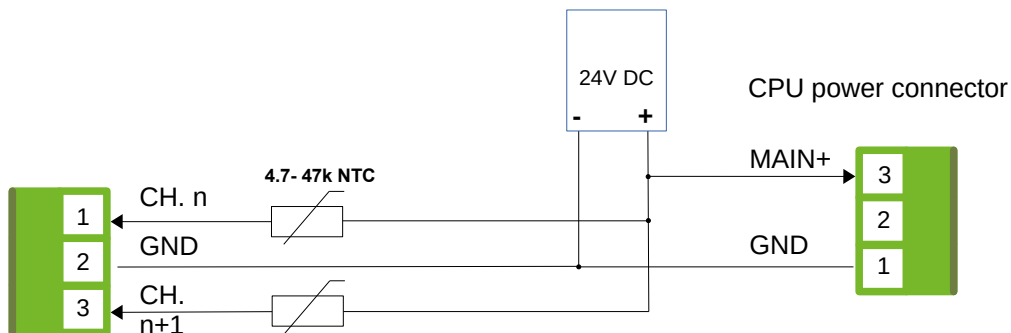

Fig. 24. Connection method for 3-wire converters with voltage output

10.4.3. Measuring temperature using NTC sensors

The processing algorithms available to users in the Ambity Line™ series enable, among other things, the use of the voltage measurement mode to measure temperature using thermistors connected directly to the measurement input. In order to use a given channel to measure temperatures by this method, the appropriate measurement value processing block (algorithm) must be implemented in the user program, and the selected measurement channel must be configured to measure voltages within the range covering the sensor supply voltage. Most often, the power supply for the sensor will be the same source that powers the entire system. This way of connecting the thermistor is shown in Figure 25.



When the same source powers the CPU, the voltage is measured internally

Fig. 25. The basic way to connect thermistors

This method of measuring temperature also requires information about the sensor's supply voltage to work properly. If the system solution in Figure 25 is used, the sensor supply voltage value is the same as that of the main unit, and it is measured inside the main unit. In the configuration of the measurement algorithm, therefore, select " V_{main} " as the source of information about this voltage.

In many cases it may be necessary to supply the thermistors from a separate source. For best accuracy it is then recommended to use a different channel for measuring the supply voltage

of the temperature sensor(s) and select this channel as the source of information in the algorithm.

It is not recommended to specify the supply voltage as a constant value in the algorithm, as this can cause significant measurement errors due to fluctuations in the actual value. The way of connecting a thermistor supplied from a separate source is shown in Figure 26.

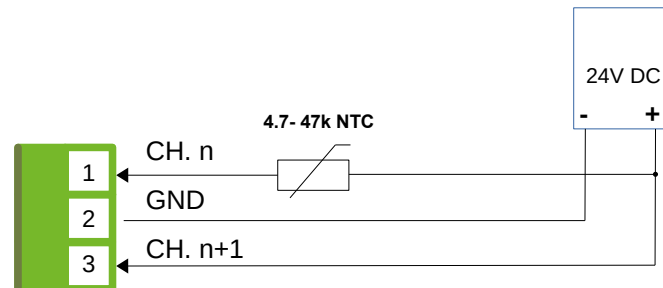

A thermistor powered from a separate source requires the use of an additional channel to measure this voltage

Fig. 26. The way to connect the thermistor when supplied from a separate source

10.4.4. Readout of digital signals

Ambity Line™ series I/O modules use solutions to ensure correct interpretation of digital signals operating in different voltage standards (LVTTTL/TTL/CMOS/12V/24V). For this purpose, an algorithm corresponding to the operation of a Schmidt gate was developed with the ability to set the threshold voltage and hysteresis width. To enable the reading of digital signals, this block must be implemented in the user program and configured accordingly. The channel, used as a digital input, is set by the hardware to measure voltages within a range that covers the maximum voltage of the signal. The simplest case involves a button with an active high state and an active state voltage of 24V - see Figure 27.

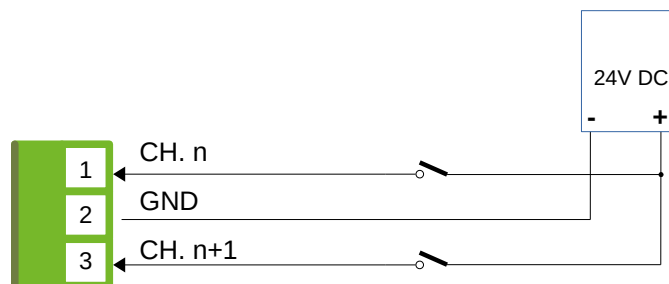

Fig. 27. Basic layout for connecting push buttons/limit switches with active state high

If it is required to provide a high state while the push button is released, then Pull-up resistors should be added in the circuit. The basic way to connect buttons in 24V logic with an active low state is shown in Figure 28.

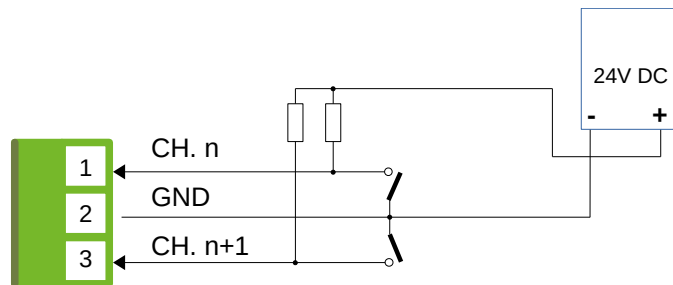

Fig. 28. Layout of connection of push buttons/limit switches in the system with active state low (Pull-up resistors with a value of 2k2 – 22k)

Similar arrangements should be used when connecting signals derived from devices equipped with OC digital outputs with active high and low states, respectively (Figures 29 and 30, respectively).

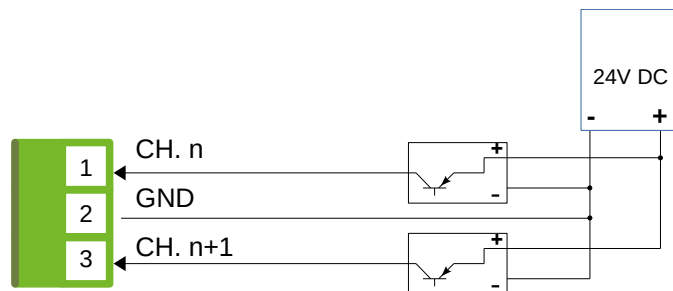

Fig. 29. Digital output signal connection circuits with active state high (Pull-up resistors with a value of 2k2 – 22k)

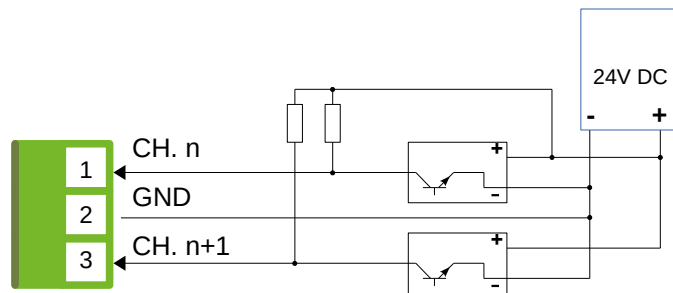

Fig. 30. Connection circuits for digital output signals with active state low (Pull-up resistors with a value of 2k2 – 22k)

To enable direct connection of digital signals (e.g., 5V-TTL), configure the threshold voltage level in the user program (e.g. 2.5V with a hysteresis of +/-0.7V). The way of connecting a device powered by 5V and TTL outputs is shown in Figure 31.

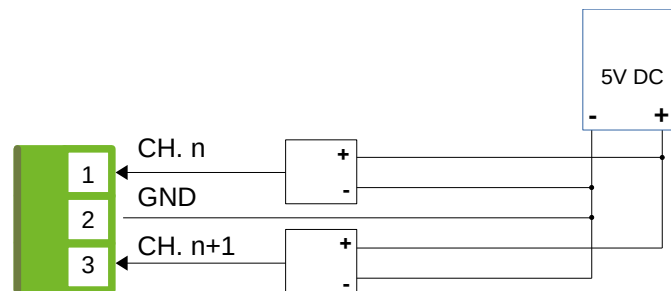

Fig. 31. Connecting TTL digital signals from the outputs of a 5V-powered device

10.4.5. Channel use in output mode

An example of how to use the OC output to control LED indicator lamps is shown in Figure 32. In the case of LED lights adapted directly to a 24V power supply, it is not necessary to use resistors.

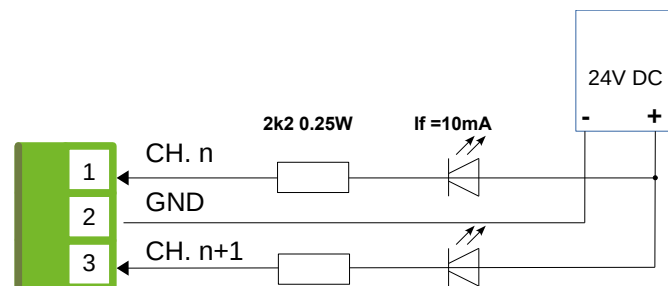

Fig. 32. Connection of LED indicator lights to OC outputs

The method of connecting the relay windings is shown in Figure 33 (the use of surge arrestors is required for inductive loads – here diodes are used). The maximum current flowing through the OC output to ground should be no more than 100mA (max. 120mA), so the resistance of the windings should not be less than 240ohm (the absolute minimum is 200ohm).

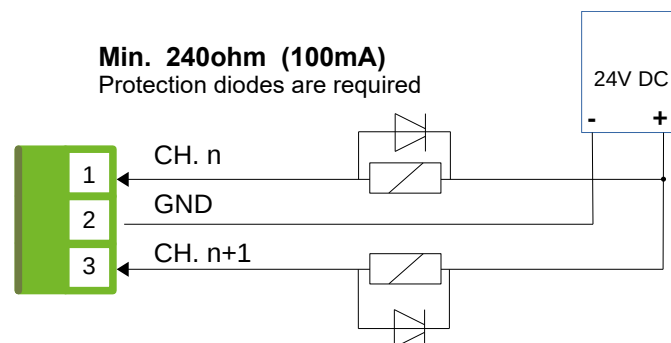

Fig. 33. Connection of relay excitation windings to OC outputs

Figure 34 shows how to connect OC outputs to digital inputs of another device. The voltage of the Pull-up power supply must be adapted to the input voltage levels of the controlled device. If the controlled device has built-in Pull-up resistors, then installing resistors and a power supply is not required.

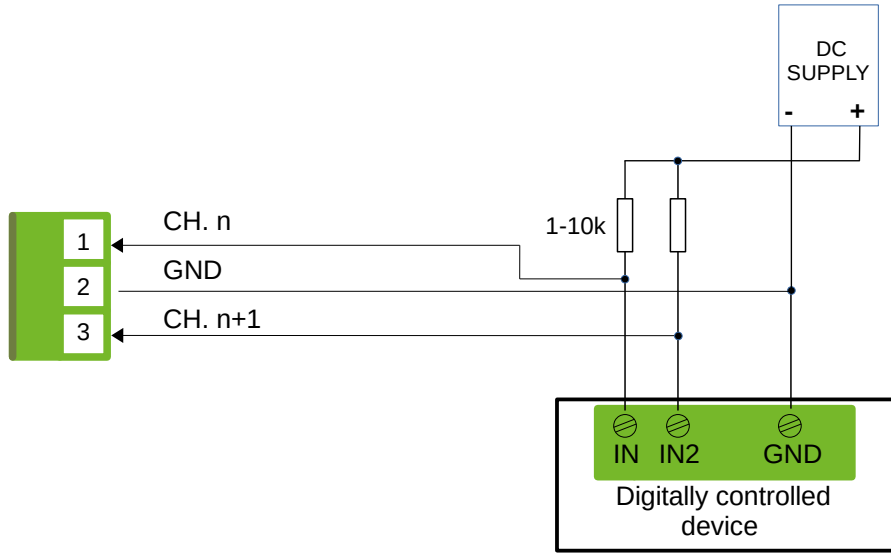

Fig. 34. Connection of relay control windings to OC outputs

11. Operation through the control panel

11.1. Button functions



ENTER ↵ button

- entering the main MENU
- entering the selected menu item
- confirmation of the selection or value of the edited parameter



ESC X button

- return to the previous menu level
- exit from the parameter edition
- cancellation of the change



Direction button UP ▲

- scrolling up
- increasing the value of the edited field



Direction button DN ▼

- scrolling down
- reducing the value of the edited field



Direction button RIGHT ►

- scrolling to the right
- changing the edited field to the next one on the right



Direction button LEFT ◀

- scrolling to the left
- changing the edited field to the next one on the left

11.2. Menu operation

The data displayed on the control panel is organized in the form of a multi-level menu (home screen, main menu, submenu).

Depending on the situation (e.g. additional confirmation required, change failure), additional messages and instructions may appear on the screen.

The home screen shows basic information about the state of the system and the user program. The main menu is accessed by pressing ENTER ↵. For security reasons, entering the menu requires the user to log in. According to the message that appears, select one of the available users and confirm the selection (ENTER ↵). If the selected user has an active PIN, they will be required to enter it.

The top row indicates the location in the menu structure. Direction arrow symbols that appear indicate possible navigation directions. Navigation is done using the directional buttons. Pressing ENTER ↵ causes entering the submenu, editing the parameter or activating the action. Pressing ESC x exits the current menu level.

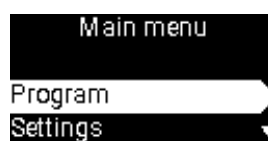

Fig. 35. View of the menu in the form of a selection list

Functions in which parameters/settings are edited in numerical values or special characters (e.g. PIN, IP address, time, date) are set using the LEFT/RIGHT (◀/▶) buttons, which the user selects the edit field, and then use the UP/DN (▲/▼) buttons to change the value. Set values are confirmed with ENTER ↵. If the set value is outside the acceptable range for a given parameter, an error message will be displayed. Pressing ESC x at any time exits edit mode without saving changes.

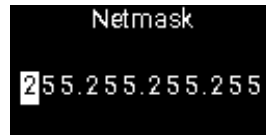

Fig. 36. Editing numerical values

Functions in which parameters/settings are edited using predefined values (e.g. baud rate, number of bits) are set using the direction buttons. The selected value is confirmed with ENTER ↵. Pressing ESC x exits the edit mode without changing the parameter value.

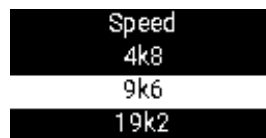

Fig. 37. Selecting a value from the selection list

Some parameters (e.g. screen brightness) are handled using a slider editor. Its value can be changed using the LEFT/RIGHT (◀/▶) buttons. The selected value is confirmed with ENTER ↵. Pressing ESC x exits the edit mode without changing the parameter value.

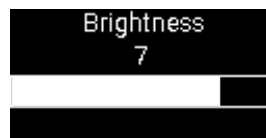

Fig. 38. Slider type editor

11.3. Menu structure

Program	
➤	Control
	<ul style="list-style-type: none"> • Run/Resume • Step/Pause • Stop • Hard_Stop
➤	Info
➤	Download
➤	Delete
Settings	
➤	System
	<ul style="list-style-type: none"> • Date & Time • Menu Timeout • Brightness • Keypad Beep
➤	Network
	<ul style="list-style-type: none"> • Status • Enable

- DHCP
- Address
- Netmask
- Gateway
- DNS mode
- DNS1 i DNS2
- NTP mode
- NTP

➤ Modbus	<i>Modbus 1</i> ▶	◀ <i>Modbus 2</i>
• Speed	• Speed	• Speed
• Stop Bits	• Stop Bits	• Stop Bits
• Parity	• Parity	• Parity
• Address	• Address	• Address
• Retries	• Retries	• Retries
• Response Timeout	• Response Timeout	• Response Timeout

Users

- Admin
- Operator

Maintenance

- Info
- Export Settings
- Import Settings
- Default Settings
- Reboot
- FW. Update
- Factory Reset

L-Bus

<i>addr: 00</i> ▶	◀ <i>addr: 01</i> ▶	◀ <i>addr: ...</i> ▶	◀ <i>addr: 10</i>
➤ Info	➤ Info	➤ Info	➤ Info
➤ Add	➤ Add	➤ Add	➤ Add
➤ Remove	➤ Remove	➤ Remove	➤ Remove
➤ FM. Update	➤ FM. Update	➤ FM. Update	➤ FM. Update

11.4. Menu functions and settings

11.4.1. Program

The Program submenu is used to manage the user program. Available functions:

- **Control** - allows you to control the user program:
 - **Run/Resume** – running the user program. If the program is in the STOP state before issuing this command, the program starts from the beginning. If the program is in the PAUSE state, the program resumes work that was previously suspended.
 - **Step/Pause** – execution of a single loop of the user program and transition to the PAUSE state. All measurement inputs are read and outputs are set according to the program logic. If the STEP command is invoked while the program is in the STOP state, the program is additionally started before a single loop is executed. If the command is invoked while the program is in the RUN state,

the device will complete the currently executing program loop and place the program in the PAUSE state.

- **Stop** – controlled stopping of the program operation. If a "shutdown procedure" is defined in the user program (e.g. setting the outputs to a certain safe state and/or sending a closing message through selected interfaces), it is performed before the end of the user program.
- **Hard_Stop** – immediate stopping of the user's program without performing the above-mentioned "shutdown procedure".
- **Info** - display information about the user program: file name, version, size and others. If the content of the program information is longer, it can be previewed by scrolling it using the direction buttons.
- **Download** - loading the user's program to the device's memory. The function is available only to the Administrator, requires additional confirmation. If the program is in the RUN state, the command will fail. User program stop is required. Selecting the command opens a window for selecting a file from a USB flash drive or microSD card. The directory structure is navigated using the direction buttons, and pressing ENTER ↵ on the indicated file starts the process of copying it to the device. The function of loading a new user program removes the existing program from Flash memory, therefore additional confirmation of this operation is required. Before loading into memory, the system checks the correctness of the file with the new program. If for some reason the new file cannot be loaded, a message with information about the reason is displayed.



If the loading of a new program has been interrupted (e.g. the medium with the program has been removed), the damaged program in the device is deleted.

- **Delete** - deletes the user's program from the device's memory (the function is available only from the ADMIN user level). If the program is in the RUN state, it will fail to delete it, it must be stopped first. After the operation is completed, the device will inform you about its progress.

11.4.2. Settings

The Settings submenu is used to manage device settings.

- **System** – system settings:
 - **Date & Time** – allows you to set the date and time. The date is displayed in the format YYYY.MM.DD and the time HH:MM:SS in the 24-hour format.
 - **Menu Timeout** – the time of automatic exit from the menu in case of user inactivity. Default value 30 seconds, available setting values: OFF, 30, 60, 120, 180, 240, 300 seconds. If the user is inactive (no keyboard presses), after this time the system automatically returns to displaying the home screen, and the logged-in user is logged out. Setting the value to OFF disables the mechanism. Disabling this feature is not recommended.
 - **Brightness** – brightness of the display. Default value 6, range of values: 1-9.
 - **Keypad Beep** – signaling keystrokes with a buzzer. Default value ON. Setting this option to OFF does not disable system signals, but only keyboard presses.
- **Network** – Ethernet network settings:
 - **Status** – displays information on the current parameters of the Ethernet network.
 - **Enable** – allows you to enable or disable the Ethernet interface.
 - **DHCP** – if this option is enabled, the settings related to the operation of the Ethernet interface are automatically assigned by the DHCP server, and the IP, Netmask and Gateway parameter values are ignored.
 - **Address** – IP address of the device. The set value is taken into account when the DHCP option is disabled.

- **Netmask** – subnet mask. The set value is taken into account when the DHCP option is disabled.
 - **Gateway** – network gateway. The set value is taken into account when the DHCP option is disabled.
 - **DNS mode** – the mode of selecting domain name server addresses. Static or Dynamic can be selected. In Static mode, the Ethernet interface uses the DNS servers defined by the DNS1 and DNS2 parameters. In Dynamic mode, DNS server addresses are defined automatically by the DHCP server, and DNS1 and DNS2 parameter values are ignored.
 - **DNS1** and **DNS2** - addresses of domain name servers. The set value is taken into account when the DNS mode parameter is in Static mode.
 - **NTP mode** – time server (NTP) address selection mode. Static or Dynamic can be selected. In Static mode, the Ethernet interface uses the NTP server defined by the NTP parameter. In Dynamic mode, the server address is defined automatically by the DHCP server and the value of the NTP parameter is ignored. NOTE: If the DHCP server does not provide the NTP server address, the device uses the time server defined by the NTP parameter (as in the Static mode).
 - **NTP** - time server address. The set value is taken into account when the NTP mode parameter is in Static mode, or the DHCP server does not provide the address of the time server.
- **Modbus** – Modbus interfaces settings:
- **Speed** - transmission speed. Default value 9.6 kbps, available values: 1.2 kb/s, 2.4 kb/s, 4.8 kbps, 9.6 kbps, 19.2 kbps, 38.4 kbps, 57.6 kbps, 115.2 kbps.
 - **Stop Bits** - number of stop bits. Default value 1, available values: 1, 2.
 - **Parity** - parity bit. Available values: NONE, EVEN, ODD, MARK.
 - **Address** – Modbus address. Default value 254, available range of values: 0 – 255. If the address was set to 0, the interface works in MASTER mode.
 - **Retries** – the maximum number of query repetitions in the absence of a response. Default value 3, available range of values: 0 - 5. Parameter important for MASTER mode.
 - **Response Timeout** - maximum waiting time for a response. Default value 100 msec, available value range: 10 - 9999 msec. Parameter important for MASTER mode.



If the device has more than one Modbus interface available to the user, the direction buttons allow you to switch between them without changing the parameter selection position for editing.



Fig. 39. Navigation between interfaces (◀▶)

11.4.3. Users

The Users submenu is used to manage users in the area of verification of access rights to device functions available from the level of:

- **Admin** - allows you to set the ADMINISTRATOR PIN. The default value is "112211". Access control for functions available from the Administrator level (PIN code request) is always active and required.

- **Operator** - allows you to set the OPERATOR PIN. Default value "000000". Setting or leaving the value 000000 disables access control (PIN code request) when logging in the Operator user.

The PIN is 6 digits.

11.4.4. Maintenance

The Maintenance submenu is used to manage the firmware (FW) of the device in the area of functions:

- **Info** – displays information about FW, HW and serial number.
- **Export Settings** - export of configuration to a file. This feature is only available to the Administrator. The user program must be in the STOP state to perform the operation.

Selecting the command allows you to save a file containing a copy of the device settings tree on the selected medium, except for Administrator and Operator PIN codes. The file is saved in the "/EDS/AL/settings/" directory under the name constituting its serial number.

- **Import Settings** - reading configuration from a file. This feature is only available to the Administrator. The user program must be in the STOP state to perform the operation.

Selecting the command opens a window for selecting a file from a USB flash drive or microSD card. The directory structure is navigated using the direction buttons, and pressing ENTER ↵ on the indicated file starts the process of copying it to the device. Administrator and Operator PINs are not taken from the file.

- **Default Settings** - setting the entire configuration tree to default values. The function is available only to the Administrator. The user program must be in the STOP state to perform the operation. The function and result are identical to the reset performed by means of the physical reset button to factory settings (see: drawings with the device view item 1 in Chapter 7), hold pressed >5 sec*.
- **Reboot** - allows you to restart the entire system in a controlled way. To perform the operation, the user program must be in the STOP state. After restarting the system, the user program must be started manually.
- **FW. Update** - allows you to install a different FM version in the CPU module. The function is available only to the Administrator. The user program must be in the STOP state to perform the operation.

The file can be downloaded from a flash drive or microSD card. The directory structure is navigated with the use of directional buttons, and pressing ENTER ↵ on the indicated file starts the process of loading it into the device memory.

It is possible to Update and Downgrade the program. The device configuration is automatically migrated, new parameters are added with default values, and unused parameters are deleted. If the new FW has not been loaded correctly, the previous FW version remains in memory and the device will continue to function as usual.



In some cases, it is not possible to directly migrate (jump) several FW versions, therefore it may be necessary to install the indicated intermediate version.

After changing the FW to an older version or a version specialized for user-dedicated applications, it is necessary to test the correctness of the user's program operation.

- **Factory Reset** - allows you to reset the device to factory settings for the installed FW version and completely clears the space available for the user program. The function is available only to the Administrator. The user program must be in the STOP state to perform the operation. The function and result are identical to the reset performed by means of the physical reset button to factory settings (see: drawings with the device view item 1 in Chapter 7), hold pressed >10 sec*.



*Using the physical factory reset button:

- with the device running, button pressed and held >5 sec. sets the entire configuration tree to default values, as with the **Default Settings** function
- with the device running, button pressed and held >10 sec. resets the device to its factory settings, as with **Factory Reset**

11.4.5. L-Bus

The L-Bus submenu allows you to manage cooperation with modules connected to the local bus connecting the CPU module with I/O modules. The address of the currently selected module is displayed at the top of the screen. To switch between modules, use the left/right ◀/▶ direction buttons.

The module built into the CPU always has the address 00, and external modules from 01 upwards.

For the module assigned and paired at a given address, the menu allows you to select the following functions:

- **Info** – displays information about the HW, FW version and the serial number of the assigned module.
- **FW. Update** - allows you to update the FW in the module. This feature is only available to the Administrator. The user program must be in the STOP state to perform the operation.

Selecting the command opens a window for selecting a file from a USB flash drive or microSD card. The directory structure is navigated using the direction buttons, and pressing ENTER ↵ on the indicated file starts the process of copying it to the device.

- **Remove** – removes the module assigned to the address. This feature is only available to the Administrator. The user program must be in the STOP state to perform the operation.

For addresses without an assigned module, the menu allows you to select the following functions:

- **Add** - enables assignment of the module to a given address. After starting it, the system waits for a short (for about 100 msec.) pressing the button to restore factory settings **in the external module (see: figure 3 point 1)**.



Do not press the factory reset button on the CPU.

Adding a module at address 0 does not require pressing the button.

12. Operating modes of external modules and their configuration



Subsystems consisting of at least one module of the Ambity Line™ (AL-IO) series can be connected to an external Modbus bus and power supply, **only when the central unit of the Ambity Line™ (AL) series is not connected to the same bus built in a DIN rail -CPU).**

It is absolutely necessary to provide power supply with parameters consistent with the technical data of the I/O modules (see chapter 7.2).

In order to ensure proper operation of the system, it is necessary to ensure proper termination of the Modbus bus. Typically, terminating resistors should be placed at both ends of the bus and their resistance should be 120 ohms.

Ambity Line™ Series CPUs (AL-CPU) must not be connected to a power supply or to any communication buses via the L-Bus. Such connection may damage the central unit.

Connection of the central unit to the Modbus bus can be done only through dedicated interfaces (see chapter 7.1).

All Ambity Line™ (AL-IO) external I/O modules can operate in 2 modes. By default, the modules are configured to work with the Ambity Line™ (AL-CPU) series CPU, and if necessary, the user can configure them to work in Modbus RTU mode. In this state, it is possible to work modules in any system with the Modbus RTU bus.

The operating modes (states) of the device are indicated by the appropriate color of the LED diode, visible on the front of the device. Green color means that the module is configured to work in L-Bus mode, and red color means Modbus RTU mode. The module operation in the L-Bus mode does not require additional configuration of the device by the user. However, it is necessary to register it in the memory of the AL-CPU central unit.

The table below describes the operating modes of the device and how to switch them using the "Factory reset" button.

Device Mode	LED	KeyPress (>0.1sec)	Hold pressed >5sec	Hold pressed >10 sec
LBUS_MODE, no communication / not registered	GREEN (continuous)	LED YELLOW, ready for registering by 10 sec	Switched to MB_MODE, addr 0xFE LED RED (continuous)	FACTORY reset; LBUS_MODE, LED GREEN continuous
LBUS_MODE, registered & communication OK	GREEN (flash 1Hz)	LED YELLOW, ready for registering by 10 sec	Switched to MB_MODE, addr 0xFE LED RED (continuous)	FACTORY reset; LBUS_MODE, LED GREEN continuous
MB_MODE, no communication	RED (continuous)	LED YELLOW forced address to 0xFF, ready for readdressing by 10 sec	Switched to LBUS_MODE, LED GREEN (continuous)	FACTORY reset; LBUS_MODE, LED GREEN continuous
MB MODE, communication OK	RED (flash 1Hz)	LED YELLOW forced address to 0xFF, ready for readdressing by 10 sec	Switched to LBUS_MODE, LED GREEN (continuous)	FACTORY reset; LBUS_MODE, LED GREEN continuous

In order to enable direct cooperation of AL-IO modules with the master device via Modbus RTU buses, these modules must first be configured to work in Modbus mode.

Then the physical connection of the AL-IO modules to the Modbus RTU bus and power supply should be carried out through the connector used to connect them to the L-Bus. The functions of individual contacts of the connector are described in Fig. 40, and the method of connection to

the Modbus RTU bus and external power supply in Fig. 41.

To make the connection, use a five-pin terminal block plug in 3.81 mm pitch.

Using a DIN rail bus to a Modbus RTU line, multiple Ambity Line™ modules can be connected simultaneously, creating a compact control and measurement subsystem in the control cabinet. Modbus RTU registers available in the AL-IO-A.xx series modules are presented in the table at the end of the chapter.

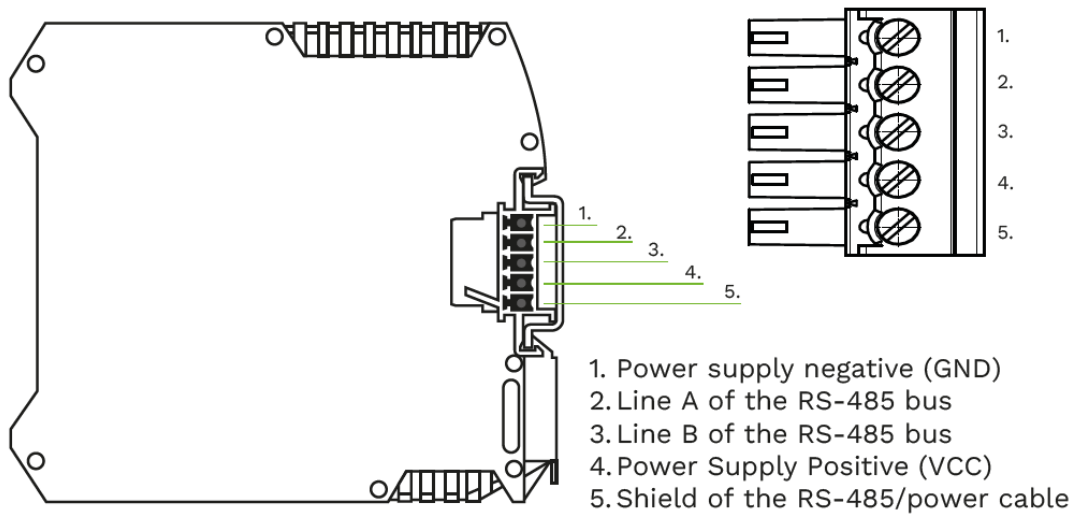

Fig. 40. Description of L-Bus connector pins

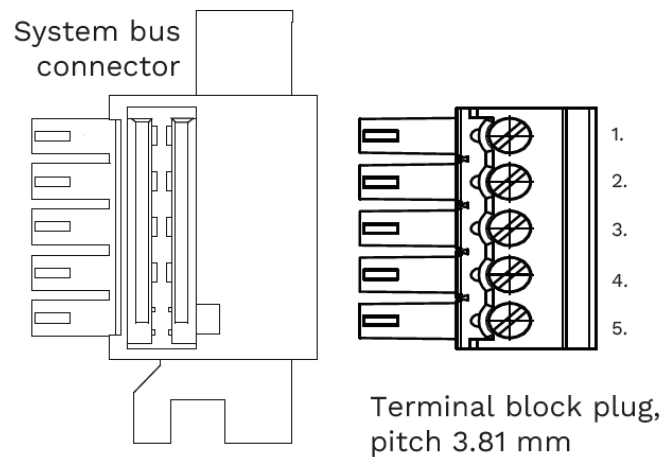

Fig. 41. The way of using the bus connectors to connect the module(s) to the Modbus bus

Table of Modbus RTU registers available in AL-IO-A.xx series modules

Addr offset (HEX) : 0x0001		0x2711		0x7531		0x9C41			
Register content	Address	Range	Address	Range	Address	Range	Address	Range	
Data for CH1	0x0001	0 ÷ 1	0x2711	0 ÷ 1	0x7531	-30000 ÷ +30000	0x9C41	0 ÷ 65535	Data availability depend on mode
Data for CH2	0x0002	0 ÷ 1	0x2712	0 ÷ 1	0x7532	-30000 ÷ +30000	0x9C42	0 ÷ 65535	Data availability depend on mode
Data for CH3	0x0003	0 ÷ 1	0x2713	0 ÷ 1	0x7533	-30000 ÷ +30000	0x9C43	0 ÷ 65535	Data availability depend on mode
Data for CH4	0x0004	0 ÷ 1	0x2714	0 ÷ 1	0x7534	-30000 ÷ +30000	0x9C44	0 ÷ 65535	Data availability depend on mode
Data for CH5	0x0005	0 ÷ 1	0x2715	0 ÷ 1	0x7535	-30000 ÷ +30000	0x9C45	0 ÷ 65535	Data availability depend on mode
Data for CH6	0x0006	0 ÷ 1	0x2716	0 ÷ 1	0x7536	-30000 ÷ +30000	0x9C46	0 ÷ 65535	Data availability depend on mode
Data for CH7	0x0007	0 ÷ 1	0x2717	0 ÷ 1	0x7537	-30000 ÷ +30000	0x9C47	0 ÷ 65535	Data availability depend on mode
Data for CH8	0x0008	0 ÷ 1	0x2718	0 ÷ 1	0x7538	-30000 ÷ +30000	0x9C48	0 ÷ 65535	Data availability depend on mode
Data for CH9	0x0009	0 ÷ 1	0x2719	0 ÷ 1	0x7539	-30000 ÷ +30000	0x9C49	0 ÷ 65535	Data availability depend on mode
Data for CH10	0x000A	0 ÷ 1	0x271A	0 ÷ 1	0x753A	-30000 ÷ +30000	0x9C4A	0 ÷ 65535	Data availability depend on mode
Data for CH11	0x000B	0 ÷ 1	0x272A	0 ÷ 1	0x753B	-30000 ÷ +30000	0x9C4B	0 ÷ 65535	Data availability depend on mode
Data for CH12	0x000C	0 ÷ 1	0x272B	0 ÷ 1	0x753C	-30000 ÷ +30000	0x9C4C	0 ÷ 65535	Data availability depend on mode
Digital OUTPUTS (packed)	---	---	---	---	---	---	0x9C51	0 ÷ 4095	All Coils gathered in one register
Digital INPUTS (packed)	---	---	---	---	0x7541	0 ÷ 4095	---	---	All Digital Inputs gathered in one register
Measurement Status For CH1	---	---	---	---	0x7551	0 ÷ 65535	---	---	
Measurement Status For CH2	---	---	---	---	0x7552	0 ÷ 65535	---	---	
Measurement Status For CH3	---	---	---	---	0x7553	0 ÷ 65535	---	---	
Measurement Status For CH4	---	---	---	---	0x7554	0 ÷ 65535	---	---	
Measurement Status For CH5	---	---	---	---	0x7555	0 ÷ 65535	---	---	
Measurement Status For CH6	---	---	---	---	0x7556	0 ÷ 65535	---	---	
Measurement Status For CH7	---	---	---	---	0x7557	0 ÷ 65535	---	---	
Measurement Status For CH8	---	---	---	---	0x7558	0 ÷ 65535	---	---	
Measurement Status For CH9	---	---	---	---	0x7559	0 ÷ 65535	---	---	
Measurement Status For CH10	---	---	---	---	0x755A	0 ÷ 65535	---	---	
Measurement Status For CH11	---	---	---	---	0x755B	0 ÷ 65535	---	---	
Measurement Status For CH12	---	---	---	---	0x755C	0 ÷ 65535	---	---	
Device Address	---	---	---	---	---	---	0x9C71	0 ÷ 255 (254)	
Baud Rate	---	---	---	---	---	---	0x9C72	0 ÷ 6 (4)	Kbps: 0=1.2; 1=2.4; 3=4.8; 4=9.6; 5=19.2; 6=38.4; 7=57.6; 8=115.2;
Stop bits	---	---	---	---	---	---	0x9C73	1 ÷ 2 (1)	
Parity	---	---	---	---	---	---	0x9C74	0 ÷ 2 (0)	0=NONE; 1=ODD; 2=EVEN
Configuration mode CH1	---	---	---	---	---	---	0x9C81	0 ÷ 5 (0)	0:0-24V; 1:0-10V; 2:0-20mA; 3:DO; 4:DI-24V; 5:DI-TTL;
Configuration mode CH2	---	---	---	---	---	---	0x9C82	0 ÷ 5 (0)	0:0-24V; 1:0-10V; 2:0-20mA; 3:DO; 4:DI-24V; 5:DI-TTL;
Configuration mode CH3	---	---	---	---	---	---	0x9C83	0 ÷ 5 (0)	0:0-24V; 1:0-10V; 2:0-20mA; 3:DO; 4:DI-24V; 5:DI-TTL;
Configuration mode CH4	---	---	---	---	---	---	0x9C84	0 ÷ 5 (0)	0:0-24V; 1:0-10V; 2:0-20mA; 3:DO; 4:DI-24V; 5:DI-TTL;
Configuration mode CH5	---	---	---	---	---	---	0x9C85	0 ÷ 5 (0)	0:0-24V; 1:0-10V; 2:0-20mA; 3:DO; 4:DI-24V; 5:DI-TTL;
Configuration mode CH6	---	---	---	---	---	---	0x9C86	0 ÷ 5 (0)	0:0-24V; 1:0-10V; 2:0-20mA; 3:DO; 4:DI-24V; 5:DI-TTL;
Configuration mode CH7	---	---	---	---	---	---	0x9C87	0 ÷ 5 (0)	0:0-24V; 1:0-10V; 2:0-20mA; 3:DO; 4:DI-24V; 5:DI-TTL;
Configuration mode CH8	---	---	---	---	---	---	0x9C88	0 ÷ 5 (0)	0:0-24V; 1:0-10V; 2:0-20mA; 3:DO; 4:DI-24V; 5:DI-TTL;
Configuration mode CH9	---	---	---	---	---	---	0x9C89	0 ÷ 5 (0)	0:0-24V; 1:0-10V; 2:0-20mA; 3:DO; 4:DI-24V; 5:DI-TTL;
Configuration mode CH10	---	---	---	---	---	---	0x9C8A	0 ÷ 5 (0)	0:0-24V; 1:0-10V; 2:0-20mA; 3:DO; 4:DI-24V; 5:DI-TTL;
Configuration mode CH11	---	---	---	---	---	---	0x9C8B	0 ÷ 5 (0)	0:0-24V; 1:0-10V; 2:0-20mA; 3:DO; 4:DI-24V; 5:DI-TTL;
Configuration mode CH12	---	---	---	---	---	---	0x9C8C	0 ÷ 5 (0)	0:0-24V; 1:0-10V; 2:0-20mA; 3:DO; 4:DI-24V; 5:DI-TTL;

13. Operation through the AL Utility™ application

The chapter will be added with the release of the production version of the utility software.

AL Utility™ utility software is an extensive tool enabling, among others: system configuration, user program management, updating module firmware, monitoring current system and process data, downloading and visualizing system, status and process data, configuring and calibrating modules.

14. Maintenance and technical support

14.1. Servicing

Under normal operating conditions, the devices do not require servicing, except for the item indicated below. For information on software updates or device diagnostics, see Chapter 11.

An element that may need to be replaced during its useful life is the clock battery in the central unit. **Battery change:**

The device must be turned off and disconnected. Remove all plugs from the sockets. The housing consists of side panels mounted with latches. The case is opened by gently pulling the side panels away from each other (hands/fingers).

To replace the clock batteries, just remove the left housing cover (looking from the front of the device, the thinnest one), and then carefully remove the main board from the device together with the display board attached to it (note! the connection is soldered). To remove the motherboard, gently grab it, preferably with three fingers (power connector, Modbus connector and rear edge) and pull it perpendicularly to its surface, making gentle swinging movements.

The measurement board will remain in the housing, held by the middle and right panels. Use a small, rigid tool (preferably non-conductive) to pry the battery out. With some practice, you can use a miniature flathead screwdriver.

The battery (CR 2025 or CR 2032) must be inserted so that the negative (-) pole of the battery is facing the plate.

To reinstall the main board, re-hold it in (three) fingers, insert the power and Modbus connectors slightly into their cutouts, then correctly insert the GOLD-PIN pins connecting the main board to the measurement board. When all 12 GOLD-PIN pins are correctly inserted into their respective sockets, press down on the main board, taking care not to damage the display board. Make sure all components are properly seated before closing the case. Dispose of the used battery in accordance with applicable local laws.

14.2. Technical support

On the site <http://edscontrollers.com/support>, using the search engine, information materials and product documentation are available, including product sheets, guides, manuals, etc.

Technical support contact:

support@edscontrollers.com

14.3. Disposal



- Devices such as main units and expansion modules contain circuit boards or components typical of electronic devices (among others, sockets, plugs, shields).
- The housings of the devices are made of polyamide (PA).
- The device (CPU) has a built-in CR2032 or CR2025 battery.



- Cardboard outer packaging, made of 100% recycled materials (recyclable cardboard).
- External labels made of paper.
- Sponge inner filling, made entirely of polyurethane (PU).
- Protective bag for plugs, connectors, etc., string bag type, made entirely of polyethylene.
- The manual is made entirely of paper.
- Dispose of the used battery in accordance with applicable local laws.

15. References

15.1. Technical data

A description of the system along with the specifications of each device is included in the Product Catalog and Product Cards, available for download:

[http://edscontrollers.com/userfiles/Product Catalog.pdf](http://edscontrollers.com/userfiles/Product%20Catalog.pdf)

15.2. Compliance

CE

RoHS

REACH

Detailed information on compliance with applicable standards, certificates or updates, especially if applicable to a particular model, are available in each time in the above-mentioned Product Cards.

EU declarations of conformity for download:

<http://edscontrollers.com/support> or <http://edscontrollers.com/information-materials>

15.3. Trademark and copyright

Detailed information is contained in the General Terms and Conditions of eDev Studio sp. z o.o., § 12 (Intellectual Property Rights), available:

<http://edscontrollers.com/terms-and-conditions>

Information and marketing materials (logo book, logos, etc.) available for download:

<http://edscontrollers.com/information-materials>

15.4. Licenses

For details on the applicable license terms, please refer to the General Terms and Conditions of eDev Studio sp. z o.o., § 11 (Software Licenses and Updates), available:

<http://edscontrollers.com/terms-and-conditions>

15.5. Guarantees

Detailed information on the applicable warranty conditions is contained in the General Terms and Conditions of eDev Studio sp. z o.o., § 6 (Warranty for defects, Guarantee), available:

<http://edscontrollers.com/terms-and-conditions>